

COMP / BAL	BAL – 12.5	BAL – 19.0	BAL – 29.0	BAL – 40.0
INTERNAL FLOORS	NO RESTRICTION	NO RESTRICTION	NO RESTRICTION	NO RESTRICTION
EXTERNAL WALLS	FOR SURFACES LESS THAN 400mm FROM THE GROUND OR THE TOP OF A DECK - APPENDIX F & TABLE E1. There are no requirements for external wall surfaces 400 mm or more from the ground or for external wall surfaces 400 mm or more above decks, carport roofs, awnings and similar elements or fittings having an angle less than 18 degrees to the horizontal and extending more than 110 mm in width from the wall (see Figure D3, Appendix D).	FOR SURFACES LESS THAN 400mm FROM THE GROUND OR THE TOP OF A DECK - APPENDIX F & TABLE E1. There are no requirements for external wall surfaces 400 mm or more from the ground or for external wall surfaces 400 mm or more above decks, carport roofs, awnings and similar elements or fittings having an angle less than 18 degrees to the horizontal and extending more than 110 mm in width from the wall (see Figure D3, Appendix D).	APPENDIX F ONLY	CANNOT BE USED
BUSHFIRE SHUTTERS	APPENDIX F & TABLE E1	APPENDIX F & TABLE E1	APPENDIX F ONLY	CANNOT BE USED
WINDOWS	APPENDIX F & TABLE E2 OR COMPLETELY PROTECTED BY BUSHFIRE SHUTTERS ABOVE OR COMPLETELY PROTECTED EXTERNALLY BY SCREENS WITH A MESH WITH A MAXIMUM APERTURE OF 2mm, MADE OF CORROSION RESISTANT STEEL, BRONZE OR ALUMINIUM	APPENDIX F & TABLE E2 OR COMPLETELY PROTECTED BY BUSHFIRE SHUTTERS ABOVE OR COMPLETELY PROTECTED EXTERNALLY BY SCREENS WITH A MESH WITH A MAXIMUM APERTURE OF 2mm, MADE OF CORROSION RESISTANT STEEL, BRONZE OR ALUMINIUM	COMPLETELY PROTECTED BY BUSHFIRE SHUTTERS ABOVE OR APPENDIX F ONLY AND FOR WINDOWS LESS THAN 400mm FOM THE GROUND OR THE TOP OF A DECK - COMPLETELY PROTECTED EXTERNALLY BY SCREENS WITH A MESH WITH A MAXIMUM APERTURE OF 2mm, MADE OF CORROSION RESISTANT STEEL, BRONZE OR ALUMINIUM	CANNOT BE USED
DOORS	APPENDIX F & TABLE E1 OR COMPLETELY PROTECTED BY BUSHFIRE SHUTTERS ABOVE OR COMPLETELY PROTECTED EXTERNALLY BY SCREENS WITH A MESH WITH A MAXIMUM APERTURE OF 2mm, MADE OF CORROSION RESISTANT STEEL, BRONZE OR ALUMINIUM	APPENDIX F & TABLE E1 OR COMPLETELY PROTECTED BY BUSHFIRE SHUTTERS ABOVE OR COMPLETELY PROTECTED EXTERNALLY BY SCREENS WITH A MESH WITH A MAXIMUM APERTURE OF 2mm, MADE OF CORROSION RESISTANT STEEL, BRONZE OR ALUMINIUM	APPENDIX F ONLY OR COMPLETELY PROTECTED BY BUSHFIRE SHUTTERS ABOVE OR COMPLETELY PROTECTED EXTERNALLY BY SCREENS WITH A MESH WITH A MAXIMUM APERTURE OF 2mm, MADE OF CORROSION RESISTANT STEEL, BRONZE OR ALUMINIUM	APPENDIX F ONLY AND COMPLETELY PROTECTED EXTERNALLY BY METAL FRAMED SCREEN DOOR WITH A MESH WITH A MAXIMUM APERTURE OF 2mm, MADE OF CORROSION RESISTANT STEEL, BRONZE OR ALUMINIUM
DECKING	APPENDIX F & TABLE E1 WHERE DECKING IS LESS THAN 300mm FROM GLAZED ELEMENT	APPENDIX F & TABLE E1 WHERE DECKING IS LESS THAN 300mm FROM GLAZED ELEMENT	APPENDIX F ONLY WHERE DECKING IS LESS THAN 300mm FROM GLAZED ELEMENT	CANNOT BE USED

APPENDIX F – SPECIES WITH INHERENT PROPERTIES DEEMED TO BE BUSHFIRE RESISTING

TRADE NAME	BOTANICAL NAME
ASH, SILVERTOP	<i>Eucalyptus sieberi</i>
BLACKBUTT	<i>Eucalyptus pilularis</i>
GUM, RIVER RED	<i>Eucalyptus camaldulensis</i>
GUM, SPOTTED	<i>Corymbia maculata</i> <i>Corymbia henryi</i> <i>Corymbia citriodora</i>
IRONBARK, RED	<i>Eucalyptus sideroxylon</i>
KWILA / MERBAU	<i>Intsia bijuga</i>
TURPENTINE	<i>Syncarpia glomulifera</i>
KARRI DECKING ONLY	<i>Eucalyptus diversicolor</i>
JARRAH DECKING ONLY	<i>Eucalyptus marginata</i>

TABLE E1 – Timber species with a density of 750 kg/m³ or greater at a 12 percent moisture content

SPECIES AS PER APPENDIX F PLUS THE FOLLOWING (ONLY SPECIES READILY AVAILABLE TO BRITTON TIMBERS ARE LISTED)

TRADE NAME	BOTANICAL NAME
BELIAN	<i>Eusideroxylon zwageri</i>
BOX, BRUSH	<i>Lophosteman confertus</i>
BROWNBARREL	<i>Eucalyptus fastigata</i>
BUBINGA	<i>Guilbourtia demeusei</i>
CHESTNUT (AUSTRALIAN)	<i>Eucalyptus sieberi, fastigata, obliqua</i>
GUM, SYDNEY BLUE	<i>Eucalyptus saligna</i>
GUM, FOREST RED	<i>Eucalyptus teteticornis</i>
IRONBARK, GREY	<i>Eucalyptus paniculata</i>
JARRAH	<i>Eucalyptus marginata</i>
KARRI	<i>Eucalyptus diversicolor</i>
MESSMATE	<i>Eucalyptus obliqua</i>
NORTHERN BOX (PELAWAN)	<i>Tristania obovata</i>
OAK, AMERICAN	<i>Quercus spp</i>
STRINGYBARK, YELLOW	<i>Eucalyptus muellerana</i>
TALLOWOOD	<i>Eucalyptus microcorys</i>
WENGE	<i>Millettia laurentii</i>

TABLE E2 - Timber species with a density of 650 kg/m3 or greater at a 12 percent moisture content

SPECIES AS PER APPENDIX F AND TABLE E1 PLUS THE FOLLOWING (ONLY SPECIES READILY AVAILABLE TO BRITTON TIMBERS ARE LISTED)

TRADE NAME	BOTANICAL NAME
BLACKWOOD	<i>Acacia melanoxylon</i>
AMOORA	<i>Amoora Spp</i>
ASH AMERICAN / CAMBIA ASH	<i>Franxinus americana</i>
BEECH EUROPEAN	<i>Fagus sylvatica</i>
DURIAN	<i>Durio, Neesia, Coelostegia Spp</i>
MAPLE AMERICAN / CAMBIA MAPLE	<i>Acer saccharum</i>
MELUNAK	<i>Pentace Spp</i>
MYRTLE TASMANIAN	<i>Nothofagus cunninghamii</i>
OAK RED AMERICAN / CAMBIA OAK	<i>Quercus rubra</i>
OAK WHITE EUROPEAN	<i>Quercus Spp</i>
PINE, CELERY TOP	<i>Phyllocladus asplenifolius</i>
ROSE GUM	<i>Eucalyptus grandis</i>
ROSEWOOD, NEW GUINNEA	<i>Pterocarpus indicus</i>
SAPELE	<i>Entandrophragma cylindricum</i>
TEAK BURMESE	<i>Tectona grandis</i>
VICTORIAN ASH	<i>Eucalyptus regnans, Eucalyptus delegatensis</i>
VITEX	<i>Vitex cofassus</i>

NOTE: TABLES E1 AND E2 ARE NOT EXHAUSTIVE.



WIT.3000.002.0108

AS 3959—2009

AS 3959—2009

Australian Standard[®]

Construction of buildings in bushfire-prone areas

STANDARDS
Australia



This Australian Standard® was prepared by Committee FP-020, Construction of Buildings In Bushfire-prone Areas. It was approved on behalf of the Council of Standards Australia on 6 March 2009.

This Standard was published on 10 March 2009.

The following are represented on Committee FP-020:

- Australasian Fire and Emergency Service Authorities Council (AFAC)
- Australian Building Codes Board
- Australian Institute of Architects
- Australian Institute of Building Surveyors
- Australian Steel Institute
- Australian Window Association Inc.
- CSIRO
- Engineers Australia
- Fire Protection Association Australia
- Housing Industry Association
- Master Builders Australia
- Plastics and Chemicals Industries Association Incorporated
- Property Council Australia
- Testing Interests (Australia)
- Think Brick Australia
- Timber Preservers Association of Australia
- Wood Council Australia

Acknowledgement is made to the New South Wales Rural Fire Service for their contribution in developing this Standard.

This Standard was issued in draft form for comment as DR 03182 and DR 05060.

Standards Australia wishes to acknowledge the participation of the expert individuals that contributed to the development of this Standard through their representation on the Committee and through the public comment period.

Keeping Standards up-to-date

Australian Standards® are living documents that reflect progress in science, technology and systems. To maintain their currency, all Standards are periodically reviewed, and new editions are published. Between editions, amendments may be issued.

Standards may also be withdrawn. It is important that readers assure themselves they are using a current Standard, which should include any amendments that may have been published since the Standard was published.

Detailed information about Australian Standards, drafts, amendments and new projects can be found by visiting www.standards.org.au

Standards Australia welcomes suggestions for improvements, and encourages readers to notify us immediately of any apparent inaccuracies or ambiguities. Contact us via email at mail@standards.org.au, or write to Standards Australia, GPO Box 476, Sydney, NSW 2001.

Australian Standard[®]

Construction of buildings in bushfire-prone areas

Originated as AS 3959—1991.
Second edition 1999.
Reissued incorporating Amendment No. 1 (December 2000).
Reissued incorporating Amendment No. 2 (December 2001).
Third edition 2009.

COPYRIGHT

© Standards Australia

All rights are reserved. No part of this work may be reproduced or copied in any form or by any means, electronic or mechanical, including photocopying, without the written permission of the publisher.

Published by Standards Australia GPO Box 476, Sydney, NSW 2001, Australia

ISBN 0 7337 9051 8

PREFACE

Development

This Standard was prepared by the Standards Australia Committee FP-020, Construction of Buildings in Bushfire-prone Areas, to supersede AS 3959—1999.

Changes to this Edition

This Edition incorporates the following changes:

- (a) The method of determining the Bushfire Attack Level (BAL) for a site (Section 2) has been revised and now comprises six categories, namely BAL—LOW, BAL—12.5, BAL—19, BAL—29, BAL—40 and BAL—FZ. These categories are based on heat flux exposure thresholds (see Table 3.1).
- (b) The methods for determining the Bushfire Attack Level now include both a step-by-step procedure, including tables that list climate, slope of ground and vegetation variations in States and Territories (Section 2) and a detailed calculated procedure contained in Appendix B. The slope of ground has also been clarified in Section 2 and a description and measurement of slope is included in Clause 2.2.4.
- (c) The construction sections have been reorganized in group-specific construction requirements by Bushfire Attack Levels (BALs), rather than by building component. There are now seven Sections, namely Section 3 (General) Section 4 (BAL—LOW, for which this Standard does not provide construction requirements), Section 5 (BAL—12.5), Section 6 (BAL—19), Section 7 (BAL—29), Section 8 (BAL—40), and Section 9 (BAL—FZ).
- (d) The construction requirements in Sections 3 to 9 have been revised to address the levels of exposure for the Bushfire Attack Levels (BALs). This Edition takes into consideration where building elements and materials that have been subjected to established test methods, such as AS 1530.4, *Methods for fire tests on building materials, components and structures, Part 4: Fire-resistance test of elements of construction*, covering fire resistance. Standards Australia technical committee FP-018, Fire Safety, has developed test methods exclusively for materials and elements of construction in bushfire-prone areas, namely, AS 1530.8.1, *Tests on elements of construction for buildings exposed to simulated bushfire attack, Part 8.1: Radiant heat and small flaming source*, which covers BAL—12.5 to BAL—40 and AS 1530.8.2, *Tests on elements of construction for buildings exposed to simulated bushfire attack, Part 8.2: Large flaming sources*, which covers BAL—FZ. Concessions for non-exposed facades are included in Section 3.
- (e) Attached structures, such as garages, have been included.
- (f) The aperture size of mesh at 2 mm is based on ember attack; the gaps and penetrations sizes at 3 mm are based on radiant heat.
- (g) A worked example of bushfire assessment is included in Appendix A and is based on the step-by-step method to assist with the requirements set out in Section 2.

Construction in Flame Zone

Whilst the majority of the Committee support the full Standard, unanimity was not reached on aspects related to BAL—FZ Flame Zone. The Committee will be asked to review this Standard, including Flame Zone construction, in light of relevant outcomes of the Victorian Royal Commission into the February 2009 bushfires.

Issues for future editions and amendments

Several issues were identified by the Committee when considering publication of this edition (which will be reconsidered by the Committee for inclusion in the next edition of this Standard or as amendments to this Standard) as follows:

- (i) *Royal Commission*—Standards Australia, with input from the Committee, will be making a submission to the Royal Commission, which is undertaking a review into the bushfires experienced in Victoria during February 2009. Research from the bushfires will assist the committee in making improvements to subsequent editions of this Standard.
- (ii) *Refuges*—Refuge areas and bunkers as 'high protection areas' will be researched and considered as a possible addition to this Standard.
- (iii) *Flame Zone (10 m setback)*—Currently, where the 10 m setback distance cannot be achieved, the performance of the elements of building construction that are less than 10 m from the classified vegetation is required to comply with AS 1530.8.2. The appropriateness of the test criteria for the risk is under consideration.
- (iv) *Grassland*—The inclusion of unmanaged grassland in the vegetation types and classifications.
- (v) *Vegetation fuel loads*—Currently, there is one representative value only for fuel loads for each vegetation category which may be conservative in some areas and consideration for multiple vegetation fuel loads will be given.
- (vi) *Steel roofs*—Tests to demonstrate the performance of steel roofs in a bushfire.
- (vii) *Tiled roofs*—The effects of wind on tiled roofs during a bushfire.
- (viii) *Aperture size of window mesh and perforated sheeting*—Ascertain the appropriate aperture size for window mesh and perforated sheeting used to protect windows and doors from ember attack.
- (ix) *Subfloors*—Requirements for the protection of subfloor spaces against ember attack. This Edition provides information concerning storage of combustible materials in the subfloor space.
- (x) *Doors*—The appropriate type of external door (solid core or glazed) for the varying levels of bushfire attack is to be researched.
- (xi) *Log construction*—The application of log construction as an exterior building element of construction.
- (xii) *Straw bale construction*—The application of straw bale construction as an exterior building element of construction.
- (xiii) *Draught excluders*—Gaps between the base of a door and the floor require a draught excluder that is non-combustible.
- (xiv) *Sarking*—Consideration is to be given to the effectiveness of sarking under different roof coverings.
- (xv) *Glazed elements*—The performance characteristics of glazed elements at elevated temperatures.
- (xvi) *Fire resistance*—Test methods for fire-resisting materials and assemblies, as currently, there is no test method available to assess the performance of fire-resisting materials such as plastics.

Research and development for the assessment of a bushfire attack, together with specific construction requirements, are continuing and the results are being considered by the Committee for inclusion in a future edition of the Standard.

Normative and Informative

The terms 'normative' and 'informative' have been used in this Standard to define the application of the appendix to which they apply. A 'normative' appendix is an integral part of a Standard, whereas an 'informative' appendix is only for information and guidance.

Notes and commentaries

The use of Notes in this Standard is of an advisory nature only. They provide explanations and guidance on recommended design consideration or technical procedures, as well as an informative cross-reference to other documents or publications.

This Standard incorporates a Commentary on some clauses. The Commentary directly follows the relevant clause, is designated by 'C' preceding the clause number and is printed in italics in a panel. The Commentary is for information only and does not need to be followed for compliance with the Standard.

CONTENTS

	<i>Page</i>
FOREWORD.....	7
SECTION 1 SCOPE AND GENERAL	
1.1 SCOPE	8
1.2 OBJECTIVE.....	8
1.3 APPLICATION	8
1.4 NORMATIVE REFERENCES.....	8
1.5 DEFINITIONS	9
1.6 PROCESS OF DETERMINING CONSTRUCTION REQUIREMENTS.....	11
1.7 BUSHFIRE ATTACK LEVEL (BAL)	12
SECTION 2 DETERMINING THE BUSHFIRE ATTACK LEVEL (BAL)	
2.1 GENERAL	14
2.2 SIMPLIFIED PROCEDURE (METHOD 1).....	14
SECTION 3 CONSTRUCTION GENERAL	
3.1 GENERAL	33
3.2 CONSTRUCTION REQUIREMENTS FOR SPECIFIC STRUCTURES.....	33
3.3 EXTERNAL MOULDINGS.....	35
3.4 HIGHER LEVELS OF CONSTRUCTION.....	35
3.5 REDUCTION IN CONSTRUCTION REQUIREMENTS DUE TO SHIELDING	36
3.6 VENTS, WEEPHOLES AND GAPS.....	38
3.7 BUSHFIRE SHUTTERS	39
3.8 TESTING TO AS 1530.8.....	40
3.9 GLAZING	40
SECTION 4 CONSTRUCTION FOR BUSHFIRE ATTACK LEVEL LOW (BAL—LOW). 41	
SECTION 5 CONSTRUCTION FOR BUSHFIRE ATTACK LEVEL 12.5 (BAL—12.5)	
5.1 GENERAL	42
5.2 SUBFLOOR SUPPORTS	42
5.3 FLOORS.....	42
5.4 EXTERNAL WALLS.....	42
5.5 EXTERNAL GLAZED ELEMENTS AND ASSEMBLIES AND EXTERNAL DOORS	43
5.6 ROOFS (INCLUDING VERANDA AND ATTACHED CARPORT ROOFS, PENETRATIONS, EAVES, FASCIAS, GABLES, GUTTERS AND DOWNPIPES)46	
5.7 VERANDAS, DECKS, STEPS, RAMPS AND LANDINGS	48
5.8 WATER AND GAS SUPPLY PIPES	49
SECTION 6 CONSTRUCTION FOR BUSHFIRE ATTACK LEVEL 19 (BAL—19)	
6.1 GENERAL	50
6.2 SUBFLOOR SUPPORTS	50
6.3 FLOORS.....	50
6.4 EXTERNAL WALLS.....	50
6.5 EXTERNAL GLAZED ELEMENTS AND ASSEMBLIES AND EXTERNAL DOORS	51
6.6 ROOFS (INCLUDING VERANDA AND ATTACHED CARPORT ROOFS, PENETRATIONS, EAVES, FASCIAS, GABLES, GUTTERS AND DOWNPIPES)54	



	<i>Page</i>
6.7 VERANDAS, DECKS, STEPS, RAMPS AND LANDINGS	56
6.8 WATER AND GAS SUPPLY PIPES	57
SECTION 7 CONSTRUCTION FOR BUSHFIRE ATTACK LEVEL 29 (BAL—29)	
7.1 GENERAL	58
7.2 SUBFLOOR SUPPORTS	58
7.3 FLOORS.....	58
7.4 EXTERNAL WALLS.....	59
7.5 EXTERNAL GLAZED ELEMENTS AND ASSEMBLIES AND EXTERNAL DOORS	59
7.6 ROOFS (INCLUDING VERANDA AND ATTACHED CARPORT ROOFS, PENETRATIONS, EAVES, FASCIAS, GABLES, GUTTERS AND DOWNPIPES).....	62
7.7 VERANDAS, DECKS, STEPS, RAMPS AND LANDINGS	64
7.8 WATER AND GAS SUPPLY PIPES	66
SECTION 8 CONSTRUCTION FOR BUSHFIRE ATTACK LEVEL 40 (BAL—40)	
8.1 GENERAL	67
8.2 SUBFLOOR SUPPORTS	67
8.3 FLOORS.....	67
8.4 EXTERNAL WALLS.....	68
8.5 EXTERNAL GLAZED ELEMENTS AND ASSEMBLIES AND EXTERNAL DOORS	68
8.6 ROOFS (INCLUDING VERANDA AND ATTACHED CARPORT ROOFS, PENETRATIONS, EAVES, FASCIAS, GABLES, GUTTERS AND DOWNPIPES).....	70
8.7 VERANDAS, DECKS, STEPS, RAMPS AND LANDINGS	72
8.8 WATER AND GAS SUPPLY PIPES	73
SECTION 9 CONSTRUCTION FOR BUSHFIRE ATTACK LEVEL FZ (BAL—FZ)	
9.1 GENERAL	74
9.2 SUBFLOOR SUPPORTS	74
9.3 FLOORS.....	74
9.4 EXTERNAL WALLS.....	75
9.5 EXTERNAL GLAZED ELEMENTS AND ASSEMBLIES AND EXTERNAL DOORS	75
9.6 ROOFS (INCLUDING VERANDA AND ATTACHED CARPORT ROOFS, PENETRATIONS, EAVES, FASCIAS, GABLES, GUTTERS AND DOWNPIPES).....	77
9.7 VERANDAS, DECKS, STEPS, RAMPS AND LANDINGS	78
9.8 WATER AND GAS SUPPLY PIPES	80
APPENDICES	
A WORKED EXAMPLE FOR THE ASSESSMENT OF BUSHFIRE ATTACK LEVEL (BAL).....	81
B DETAILED METHOD FOR DETERMINING THE BUSHFIRE ATTACK LEVEL (BAL)—METHOD 2.....	83
C PROCESS AND PROCEDURE FOR DETERMINING THE BUSHFIRE ATTACK LEVEL (BAL)	95
D ILLUSTRATIONS	96
E TIMBER SPECIES AND DENSITIES	101
F BUSHFIRE-RESISTING TIMBER.....	105
G EXPLANATION OF BUSHFIRE ATTACK LEVELS (BALs)	107

FOREWORD

This Standard is primarily concerned with improving the ability of buildings in designated bushfire-prone areas to better withstand attack from bushfire thus giving a measure of protection to the building occupants (until the fire front passes) as well as to the building itself.

Improving the design and construction of buildings to minimize damage from the effects of bushfire is but one of several measures available to property owners and occupiers to address damage during bushfire. Property owners should be aware that this Standard is part of a process that aims to lessen the risk of damage to buildings occurring in the event of the onslaught of bushfire. Other measures of mitigating damage from bushfire fall within the areas of planning, subdivision, siting, landscaping and maintenance.

Research is continuing with regards to the effects of bushfires on buildings, determination of bushfire-prone areas within various States and particular construction techniques designed to maximize the performance of buildings when subjected to bushfire attack. The outcomes of this research will be reflected in subsequent editions of this Standard.

The measures set out in this Standard to improve construction, and thus better equip a building to withstand the effects from bushfire, may also be used as a guide for those who wish to voluntarily adopt such measures in situations where regulatory compliance is not mandated.

Although this Standard provides for the highest Bushfire Attack Level (BAL), that is, BAL—FZ, there may be circumstances advised by authorities having jurisdiction that building in a particular bushfire location is either not recommended or not permitted based on unrealistic risk exposures.

Of significance to this Standard is the publication (in 2007) of methods of test whereby building materials, elements of construction and systems subjected to the tests of the AS 1530.8 series will satisfy the construction requirements prescribed in Sections 5 to 9 of this Standard. These methods are AS 1530.8.1, *Methods for fire tests on building materials, components and structures, Part 8.1: Tests on elements of construction for buildings exposed to simulated bushfire attack—Radiant heat and small flaming sources* and AS 1530.8.2, *Methods for fire tests on building materials, components and structures, Part 8.2: Tests on elements of construction for buildings exposed to simulated bushfire attack—Large flaming sources*.

The modelling procedure for the assessment of Bushfire Attack Level (BAL) in this Standard uses the nominal inputs shown in Table 2.4.1 with an assumed flame temperature of 1090 K. The outputs result in the production of Tables 2.4.2 to 2.4.5. Adoption of flame temperature is a jurisdictional matter.

It should be borne in mind that the measures contained in this Standard cannot guarantee that a building will survive a bushfire event on every occasion. This is substantially due to the unpredictable nature and behaviour of fire and extreme weather conditions.

STANDARDS AUSTRALIA

Australian Standard Construction of buildings in bushfire-prone areas

SECTION 1 SCOPE AND GENERAL

1.1 SCOPE

This Standard specifies requirements for the construction of buildings in bushfire-prone areas in order to improve their resistance to bushfire attack from burning embers, radiant heat, flame contact and combinations of the three attack forms.

Although this Standard is designed to improve the performance of buildings when subjected to bushfire attack in designated bushfire-prone areas there can be no guarantee that a building will survive a bushfire event on every occasion. This is substantially due to the unpredictable nature and behaviour of fire and extreme weather conditions.

NOTES:

- 1 The construction measures contained in this Standard are not the only measures that can be considered to address bushfire attack as there are other means available that are outside the scope of this Standard. Standards Australia's Handbook HB 36 provides further information on these issues.
- 2 On the basis that the committee is not aware of any clear evidence that smoke from a bushfire entering a building is a risk, this Standard does not address the infiltration of smoke nor any associated health risk.

1.2 OBJECTIVE

1.2.1 Objective of this Standard

The objective of this Standard is to prescribe particular construction details for buildings to reduce the risk of ignition from a bushfire while the fire front passes.

1.2.2 Objective of this Edition

The objective of this Edition is to provide additional and detailed methods of assessing bushfire attack commensurate with the applicable construction requirements at increased increments when compared to the previous edition.

1.3 APPLICATION

This Standard is limited to those sites where the Bushfire Attack Level (BAL) has been determined as BAL—LOW, BAL—12.5, BAL—19, BAL—29, BAL—40 or BAL—FZ (see Table 3.1).

NOTE: Although there are no specific construction requirements in the BAL designated as LOW, this does not imply these buildings are not at risk.

1.4 NORMATIVE REFERENCES

The following documents are indispensable to the application of this Standard.

AS	
1288	Glass in buildings—Selection and installation
1530	Methods for fire tests on building materials, components and structures
1530.1	Part 1: Combustibility test for materials



- AS
- 1530.2 Part 2: Test for flammability of materials
- 1530.4 Part 4: Fire-resistance test of elements of construction
- 1530.8.1 Part 8.1: Tests on elements of construction for buildings exposed to simulated bushfire attack—Radiant heat and small flaming sources
- 1530.8.2 Part 8.2: Tests on elements of construction for buildings exposed to simulated bushfire attack—Large flaming sources
- 1684 Residential timber-framed construction
- 1684.2 Part 2: Non-cyclonic areas
- 1684.3 Part 3: Cyclonic areas
- 1720 Timber structures
- 1720.2 Part 2: Timber properties
- AS/NZS
- 3837 Method of test for heat and smoke release rates for materials and products using an oxygen consumption calorimeter
- ASTM
- D2898 Standard Practice for Accelerated Weathering of Fire-Retardant-Treated Wood for Fire Testing
- BCA Building Code of Australia
- Atlas of Australian Resources—Volume 6 Vegetation, Australian Surveying and Land Information Group, Department of Administrative Services, Canberra, 1990.

1.5 DEFINITIONS

For the purpose of this Standard, the definitions below apply.

1.5.1 Bushfire

An unplanned fire burning in vegetation; also referred to as wildfire.

1.5.2 Bushfire attack

Burning embers, radiant heat or flame generated by a bushfire, which might result in ignition and subsequent damage or destruction of a building.

1.5.3 Bushfire-prone area

An area that is subject to, or likely to be subject to, bushfire attack.

1.5.4 Bushfire-resisting timber

Timber that meets the criteria specified in Appendix F.

1.5.5 Classified vegetation

Vegetation that has been classified in accordance with Clause 2.2.3.

1.5.6 Combustible

Combustible as determined by AS 1530.1.

1.5.7 Decking

That part of the structure of verandas, decks, steps, ramps and landings that forms the trafficable surface of the structure.

1.5.8 Doorframe

The frame surrounding and supporting a door where the frame consists of two jambs, a head and sometimes a transom and a sill, and is machined or made from solid stock or with a planted doorstep (Figure 3.2).

1.5.9 Effective slope

The slope under that classified vegetation which most influences the bushfire attack (see Figure 2.2).

1.5.10 Ember attack

Smouldering or flaming windborne debris that is capable of entering or accumulating around a building and may ignite the building or other combustible materials and debris.

1.5.11 Ember guard

A cover inserted in or over an opening or cavity to prevent the entry of burning embers.

1.5.12 Fire Danger Index (FDI)

The chance of a fire starting, its rate of spread, its intensity and the difficulty of its suppression, according to various combinations of air temperature, relative humidity, wind speed and both the long- and short-term drought effects.

NOTE: This Standard has adopted the equations for the Forest Fire Danger Index by Noble I.R., Bary G.A.V. and Gill A.M. 1980.

1.5.13 Fire resistance level (FRL)

The nominal grading period, in minutes, that is determined by subjecting a specimen to the standard time temperature curve regime as set out in AS 1530.4, to specify—

- (a) structural adequacy,
- (b) integrity, and
- (c) insulation,

which are expressed in that order.

NOTE: For example, a building element with an FRL of 120/60/30 will maintain, when tested in accordance with AS 1530.4—

- (a) structural adequacy for a period of 120 min;
- (b) integrity for a period of 60 min; and
- (c) insulation for a period of 30 min.

1.5.14 Flame temperature

The assumed effective flame temperature sustained for a 2 min period over a fire front width of 100 m. Instantaneous flame temperature may peak above 1200 K.

1.5.15 Flame Zone (FZ)

The highest level of bushfire attack as a consequence of direct exposure to flames from the fire front in addition to heat flux and ember attack.

1.5.16 Flammability index

The index number as determined by AS 1530.2.

1.5.17 Foliage cover

The proportion of the ground that would be shaded by foliage when the sun is shining directly overhead, expressed as a percentage for each stratum or identifiable layer of vegetation.

1.5.18 Glazed assembly

Any combination of glass and any other material that fills a window or door opening; also known as a glazing system.

**1.5.19 Non-combustible**

Not deemed combustible as determined by AS 1530.1 or not deemed combustible in accordance with the BCA.

1.5.20 Overstorey

The canopy, being the tallest stratum of the vegetation profile.

1.5.21 Relevant authority

An independent agency authorized by legislation or regulation to issue determinations, orders, or other instructions in respect of any subject covered by this Standard.

1.5.22 Resistance to the incipient spread of fire (in respect of a floor system)

The ability of the membrane to insulate and thereby limit the rise in temperature of the combustible elements of the floor system to a level that will not permit the rapid and general spread of fire throughout the floor system and to any adjoining fire compartments, in accordance with AS 1530.4.

1.5.23 Sarking-type material

A material, such as a reflective foil or other flexible membrane, normally used for a purpose such as water proofing, vapour proofing or thermal reflectance.

1.5.24 Shall

Indicates a mandatory requirement.

1.5.25 Should

Indicates a recommendation or that which is advisory but not mandatory.

1.5.26 Site

The part of the allotment of land on which a building stands or is to be erected.

1.5.27 Understorey

The vegetation beneath the overstorey.

1.6 PROCESS OF DETERMINING CONSTRUCTION REQUIREMENTS

The process for determining construction requirements is diagrammatically shown in Figure 1.1.

C1.6 Before construction requirements covered by this Standard can be determined, it is first necessary to determine the Bushfire Attack Level (BAL) by an assessment of the subject allotment and classified vegetation impacting on the site. Assessment methodologies are provided in Section 2 and Appendices A and B. The assessment outcomes are expressed in BALs and radiant heat levels provide the range on which the construction requirements are based.

1.7 BUSHFIRE ATTACK LEVEL (BAL)

The following Bushfire Attack Levels (BAL), based on heat flux exposure thresholds (see Table 3.1), are used in this Standard:

BAL—LOW

BAL—12.5

BAL—19

BAL—29

BAL—40

BAL—FZ

NOTE: Refer to Appendix G for a description of the threats associated with each BAL.

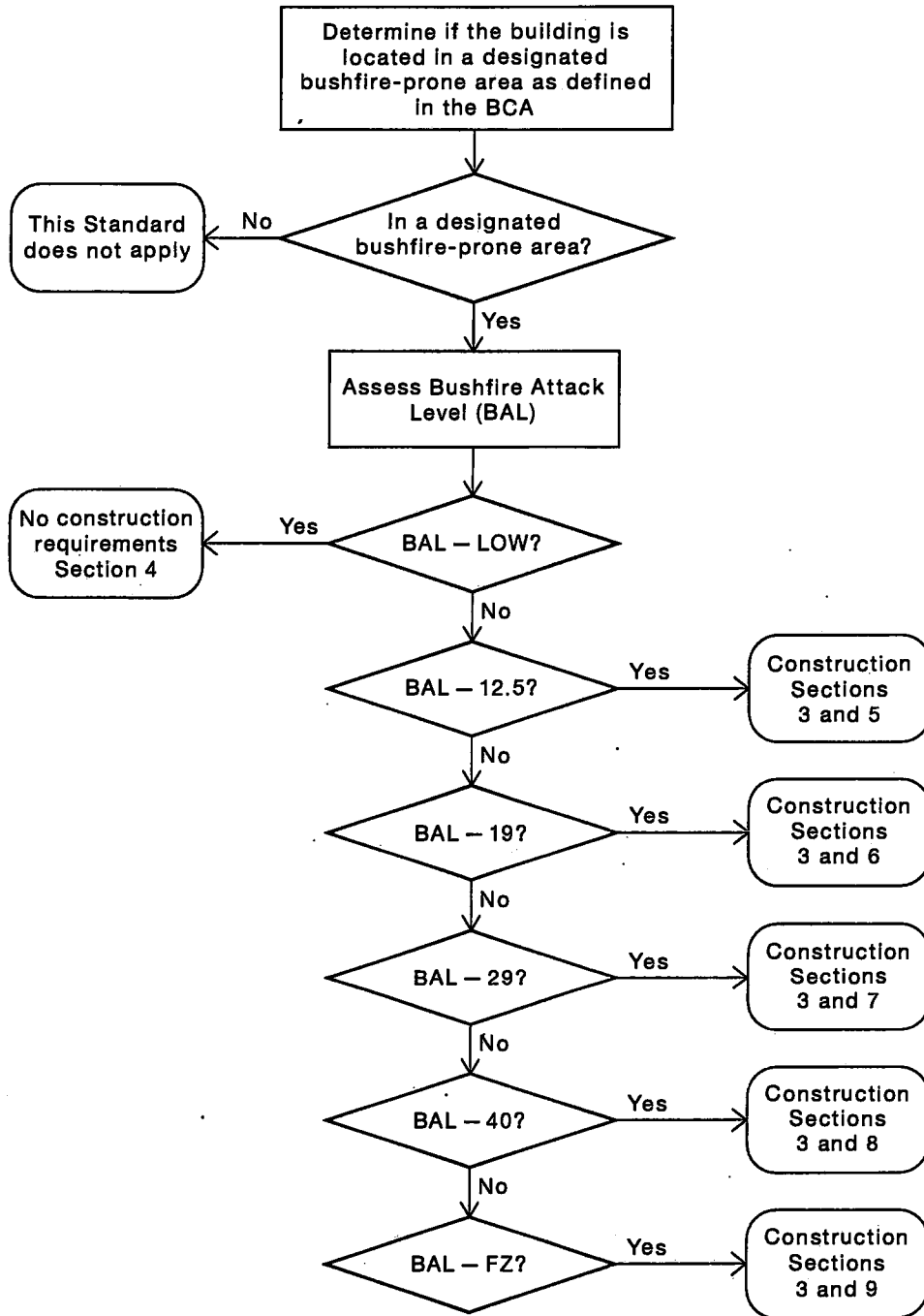

FIGURE 1.1 FLOW DIAGRAM SHOWING THE PROCESS FOR DETERMINING CONSTRUCTION REQUIREMENTS

SECTION 2 DETERMINING THE BUSHFIRE ATTACK LEVEL (BAL)

2.1 GENERAL

The Bushfire Attack Level (BAL) shall be determined by using the—

- (a) simplified procedure described in Clause 2.2 (Method 1); *or*
NOTE: See Appendix C for a flow diagram to summarize the process.
- (b) detailed procedure described in Appendix B (Method 2).

BALs are based on levels of exposure defined in Table 3.1.

C2.1 *There are two methods for determining BALs:*

Method 1—a simplified procedure that involves five procedural steps to determine BALs, and is subject to limitations on the circumstances in which it can be used (see Appendix C).

Method 2—a detailed procedure using calculations to determine BALs where a more specific result is sought or where the site conditions are outside of the scope of the simplified procedure (Method 1) (see Appendix B).

BALs are used to determine which, if any, construction requirements contained in Sections 3 to 9 of this Standard are appropriate for a particular site.

2.2 SIMPLIFIED PROCEDURE (METHOD 1)

2.2.1 General

For the simplified procedure (Method 1), the following steps shall be used to determine the BAL for all circumstances except where the effective slope under the classified vegetation, calculated in accordance with Clause 2.2.5, is more than 20° downslope.

Step	Clause	Procedure
Step 1	2.2.2	Determine the relevant FDI (see Table 2.1).
Step 2	2.2.3	Determine the classified vegetation type(s) (see Table 2.3 and Figure 2.3).
Step 3	2.2.4	Determine the distance of the site from the classified vegetation type(s) [(Point A to Point B see Figure 2.1)].
Step 4	2.2.5	Determine the effective slope(s) under the classified vegetation type(s) (see Figure 2.2).
Step 5	2.2.6	Determine the BAL from the appropriate table (see Tables 2.4.2, 2.4.3, 2.4.4 and 2.4.5, and refer to Table 2.4.1 for input values used in developing the Tables).
Step 6	2.2.7	Determine the appropriate construction requirements.

2.2.2 Step 1—Relevant Fire Danger Index (FDI)

The relevant FDI shall be determined in accordance with Table 2.1 for the identified jurisdiction or region within a jurisdiction.



TABLE 2.1
JURISDICTIONAL AND REGIONAL VALUES FOR FDI

State/region	FDI
Australian Capital Territory	100
New South Wales	
(a) Greater Hunter, Greater Sydney, Illawarra/Shoalhaven, Far South Coast and Southern Ranges fire weather districts	100
(b) NSW alpine areas	50
(c) NSW general (excluding alpine areas, Greater Hunter, Greater Sydney, Illawarra/Shoalhaven, Far South Coast and Southern Ranges fire weather districts)	80
Northern Territory	40
Queensland	40
South Australia	80
Tasmania	50
Victoria	
(a) Victoria alpine areas	50
(b) Victoria general (excluding alpine areas)	100
Western Australia	80

NOTES:

- 1 The FDI values may be able to be refined within a jurisdiction or region where sufficient climatological data is available and in consultation with the relevant regulatory authority.
- 2 The FDI values were provided by the Australasian Fire and Emergency Service Authorities Council (AFAC).
- 3 Alpine and sub-alpine areas are defined as per the Building Code of Australia, Volume Two.

2.2.3 Step 2—Vegetation classification**2.2.3.1 General**

Vegetation shall be classified in accordance with Table 2.3 and Figures 2.4(A) to 2.4(G). Where there is more than one vegetation type, each type shall be classified separately with the worst case scenario (predominant vegetation is not necessarily the worst case scenario) applied.

NOTE: Classification of vegetation should not be based solely on the edge of the vegetation, which may be invaded by weeds.

2.2.3.2 Exclusions—Low threat vegetation and non-vegetated areas

The Bushfire Attack Level shall be classified BAL—LOW where the vegetation is one or a combination of any of the following:

- (a) Vegetation of any type that is more than 100 m from the site.
- (b) Single areas of vegetation less than 1 ha in area and not within 100 m of other areas of vegetation being classified.
- (c) Multiple areas of vegetation less than 0.25 ha in area and not within 20 m of the site, or each other.
- (d) Strips of vegetation less than 20 m in width regardless of length and not within 20 m of the site or each other, or other areas of vegetation being classified.
- (e) Non-vegetated areas, including waterways, roads, footpaths, buildings and rocky outcrops.

- (f) Low threat vegetation, including managed grassland, maintained lawns, golf courses, maintained public reserves and parklands, botanical gardens, vineyards, orchards, cultivated ornamental gardens, commercial nurseries, nature strips and wind breaks.

2.2.4 Step 3—Distance of the site from classified vegetation

For each vegetation type classified in Clause 2.2.3, determine the distance of the site from the classified vegetation, measured in the horizontal plane (see Figure 2.1, Point A to Point B).

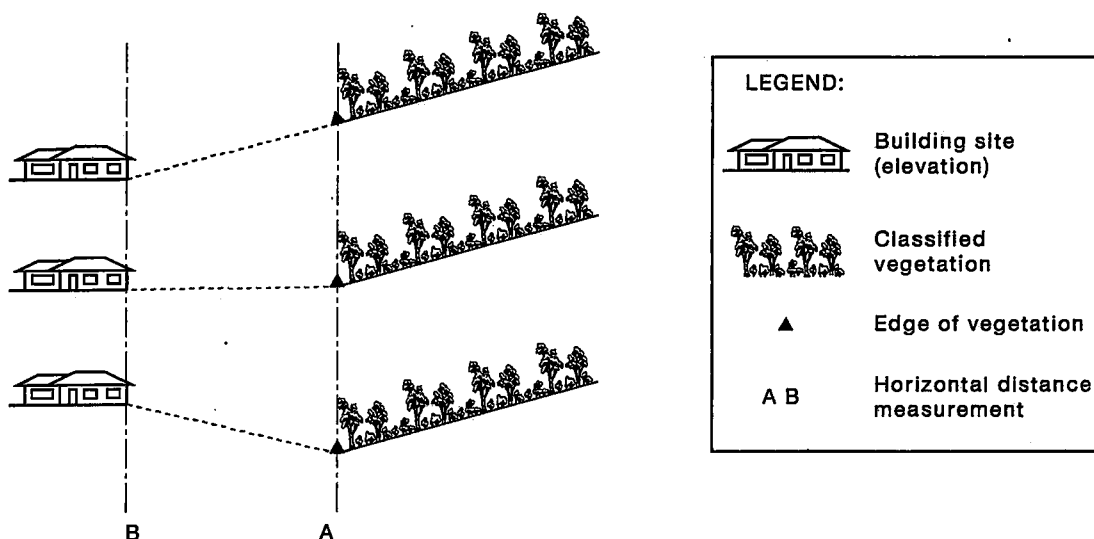

NOTES:

- 1 The measurement of distance A to B is measured in plan (i.e., horizontally) and is taken to the external wall of the proposed building, or for parts of the building that do not have external walls (including carports, verandas, decks, landings, steps and ramps), to the supporting posts or columns. The following parts of the building are excluded when determining the distance A to B:
 - (a) Eaves and roof overhangs.
 - (b) Rainwater and domestic fuel tanks.
 - (c) Chimneys, pipes, cooling or heating appliances or other services.
 - (d) Unroofed pergolas.
 - (e) Sun blinds.
 - (f) Landings, terraces, steps and ramps, not more than 1 m in height.
- 2 In the three illustrations above, the distance A to B is the same horizontal distance from the classified vegetation to the site. The area between A and B may contain vegetation not required to be classified in accordance with Clause 2.2.3.

FIGURE 2.1 DETERMINATION OF DISTANCE OF SITE FROM CLASSIFIED VEGETATION

2.2.5 Step 4—Effective slope of land under the classified vegetation

‘Slope’ refers to the slope under the classified vegetation in relation to the building—not the slope between the vegetation and the building.

For each vegetation type classified in Clause 2.2.3, determine the effective slope (in degrees) of the land under the classified vegetation and whether it is upslope or downslope in relation to the site (see Figure 2.2).

Effective slope of land under classified vegetation is presented in degrees, approximate slope ratios and percentages. As fires travel slower down a hill, all classified vegetation that is upslope will assume a value of 0° (i.e., flat land). Table 2.2 provides comparisons between degrees, slope ratios and percentages.

C2.5 The slope of the land under the classified vegetation is much more important than the slope of the land between the site and the edge of the classified vegetation. The slope of the land under the classified vegetation has a direct influence on the rate of fire spread, the severity of the fire and the ultimate level of radiant heat flux.

For Method 1 it is not important to determine the slope of the land between the site and the edge of the classified vegetation (see Figure 2.1, Point B to Point A). The further the distance the less radiant heat reaches the site.

It may be necessary to consider the slope under the classified vegetation for distances greater than 100 m in order to determine the effective slope for that vegetation classification.

Where the slope of the land under the classified vegetation is downhill from the edge of the classified vegetation nearest the site, it is considered 'downslope' regardless of the slope of the land between the site and the edge of the classified vegetation (see Figure 2.2).

Where the slope of the land under the classified vegetation is uphill from the edge of the classified vegetation nearest the site, it is considered 'upslope' regardless of the slope of the land between the site and the edge of the classified vegetation (see Figure 2.2).

TABLE 2.2
SLOPE COMPARISONS

Degrees	Ratio	Percentages
45	1:1	100
34	1:1.5	66
26	1:2	50
21	1:2.5	40
18	1:3	33
15	1:3.5	28
14	1:4	25
12	1:4.5	22
11	1:5	20
10	1:5.5	18
9	1:6	16
9	1:6.5	15
8	1:7	14
8	1:7.5	13
7	1:8	12
7	1:8.5	11
6	1:9	11
6	1:10	10
5	1:11	9
5	1:12	8
4	1:13	8
4	1:14	7
4	1:15	7
4	1:16	6
3	1:17	6
3	1:18	5.5
3	1:19	5
3	1:20	5

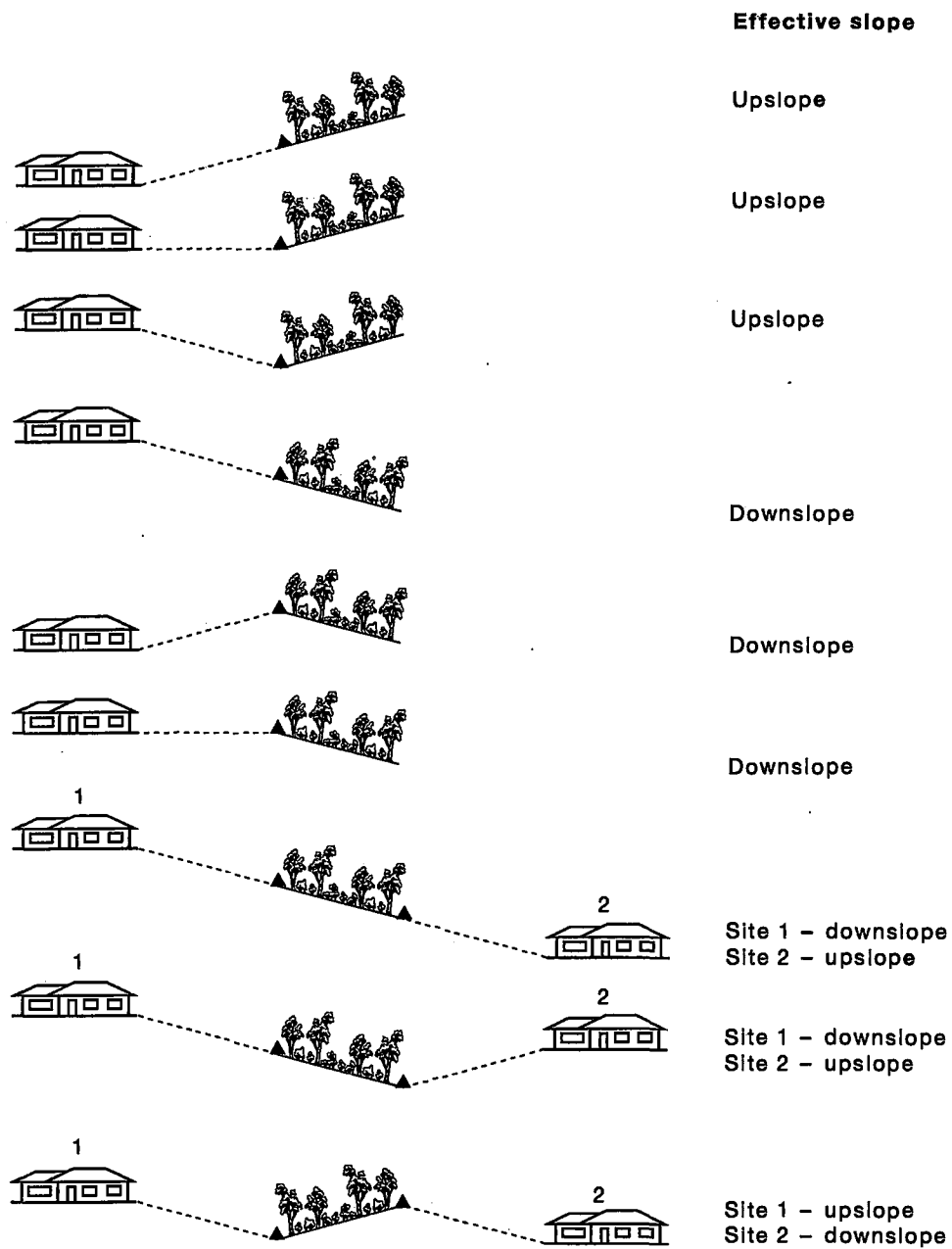

LEGEND:



Building site (elevation)



Classified vegetation



Edge of classified vegetation

NOTE: Effective 'slope' refers to the slope under the classified vegetation in relation to the building—not the slope between the classified vegetation and the building.

FIGURE 2.2 DETERMINATION OF EFFECTIVE UPSLOPE AND DOWNSLOPE

2.2.6 Step 5—Determination of Bushfire Attack Level (BAL)

The determination of Bushfire Attack Level (BAL) for a site using Method 1 shall be determined in accordance with the following:

- (a) Select the relevant table from Tables 2.4.2 to 2.4.5 based on the FDI determined at Clause 2.2.2 (Step 1).
- (b) Using the relevant table, determine the Bushfire Attack Level (BAL) for each of the vegetation classifications determined at Clause 2.2.3 (Step 2), the distance from the site determined at Clause 2.2.4 (Step 3) and the effective slope determined at Clause 2.2.5 (Step 4).
- (c) Select the highest Bushfire Attack Level (BAL) obtained from Item (b) above.

NOTES:

- 1 The determination in Tables 2.4.2, 2.4.3, 2.4.4 and 2.4.5 are based on input values contained in Table 2.4.1.
- 2 A worked example of determining the Bushfire Attack Level (BAL) is shown in Appendix A and is based on inputs contained in Table 2.4.1.
- 3 Where any of the input values contained in Table 2.4.1 are not appropriate for the site being assessed, the assessment should adopt the detailed approach given in Appendix B (Method 2).

2.2.7 Step 6—Determination of the appropriate construction requirements

Proceed to Section 3 to determine the appropriate construction requirements.

TABLE 2.3
CLASSIFICATION OF VEGETATION

Vegetation classification (see Tables 2.4.2–2.4.5)	Vegetation type	Figure No. in Fig. 2.3 and Figs 2.4(A) to 2.4(G)	Description	
A Forest	Tall open forest Tall woodland	01 02	Trees over 30 m high; 30–70% foliage cover (may include understorey ranging from rainforest and tree ferns to low trees and tall shrubs). Found in areas of high reliable rainfall. Typically dominated by eucalypts.	
	Open forest Low open forest	03 04	Trees 10–30 m high; 30–70% foliage cover (may include understorey of sclerophyllous low trees and tall scrubs or grass). Typically dominated by eucalypts.	
	Pine plantation	Not shown in Figure 2.3	Trees 10–30 m in height at maturity, generally comprising <i>Pinus</i> species or other softwood species, planted as a single species for the production of timber.	
B Woodland	Woodland Open woodland	05 06	Trees 10–30 m high; 10–30% foliage cover dominated by eucalypts; understorey low trees to tall shrubs typically dominated by <i>Acacia</i> , <i>Callitris</i> or <i>Casuarina</i> .	
	Low woodland Low open woodland Open shrubland	07 08 09	Low trees and shrubs 2–10 m high; foliage cover less than 10%. Dominated by eucalypts and <i>Acacias</i> . Often have a grassy understorey or low shrubs. <i>Acacias</i> and <i>Casuarina</i> woodlands grade to <i>Atriplex</i> shrublands in the arid and semi-arid zones.	
	C Shrubland	Closed heath Open heath	10 11	Found in wet areas affected by poor soil fertility or shallow soils. Shrubs 1–2 m high often comprising <i>Banksia</i> , <i>Acacia</i> , <i>Hakea</i> and <i>Grevillea</i> . Wet heaths occur in sands adjoining dunes of the littoral (shore) zone. Montane heaths occur on shallow or water-logged soils.
		Low shrubland	12	Shrubs <2 m high; greater than 30% foliage cover. Understoreys may contain grasses. <i>Acacia</i> and <i>Casuarina</i> often dominant in the arid and semi-arid zones.
D Scrub	Closed scrub	13	Found in areas wet enough to support eucalypt trees, which are affected by poor soil fertility or shallow soils. >30% foliage cover. Dry heaths occur in rocky areas. Shrubs 1–2 m high. Typical of coastal wetlands.	
	Open scrub	14	Trees greater than 2 m high, 10–30% foliage cover. Dominated by eucalypts or co-dominant <i>Melaleuca</i> and <i>Myoporum</i> with a mixed understorey.	
E Mallee/ Mulga	Tall shrubland	15	Vegetation dominated by shrubs (especially eucalypts and <i>Acacias</i>) with a multi-stemmed habit; usually greater than 2 m in height <30% foliage cover. Understorey of widespread to dense low shrubs (<i>Acacia</i>) or sparse grasses.	
F Rainforest	Tall closed forest Closed forest Low closed forest	16 17 18	Trees 10–40 m in height; >90% foliage cover; understorey may contain a large number of species with a variety of heights.	
	G Grassland (unmanaged) (Appears in Table 2.4.4 FDI 50 only (see Note 1))	Low open shrubland Hummock grassland	19 20	All forms, including situations with shrubs and trees, if the overstorey foliage cover is less than 10%.
		Closed tussock grassland Tussock grassland	21 22	
Open tussock Sparse open tussock		23 24		
Dense sown pasture Sown pasture		25 26		
Open herbfield Sparse open herbfield		27 28		

NOTES:

- Grassland, although classified as unmanaged, is not considered in the Bushfire Attack Level (BAL) (see Clause 2.2.3.2), except in Tasmania.
- Overstoreys of open woodland, low open woodland, tall open shrubland and low open shrubland should be classified to the vegetation type on the basis of their understoreys; others to be classified on the basis of their overstoreys.
- Vegetation height is the average height of the top of the overstorey.

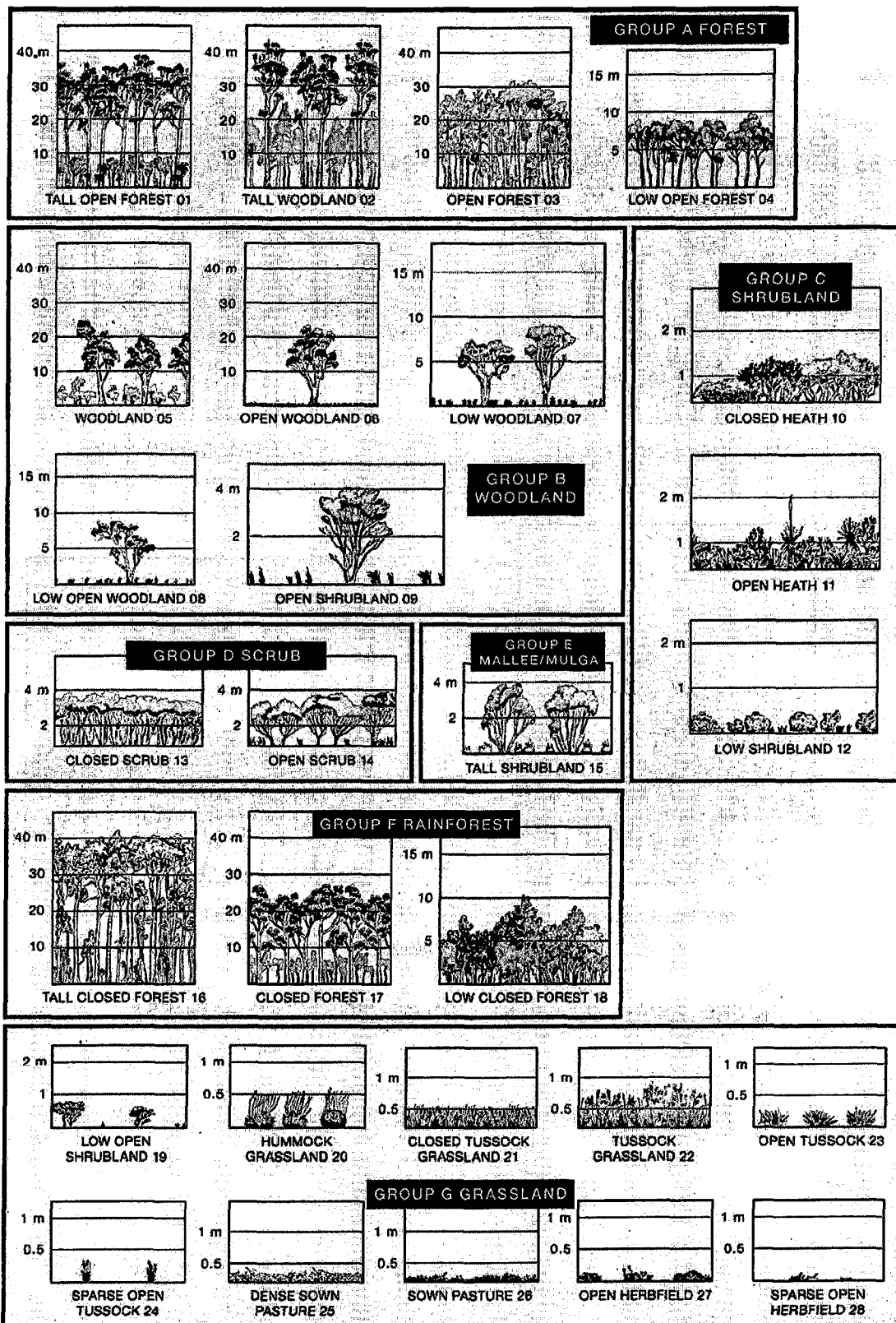

NOTE: Refer to Figures 2.4(A) to 2.4(G) for greater vegetation detail.

FIGURE 2.3 CLASSIFICATION OF VEGETATION—SUMMARY

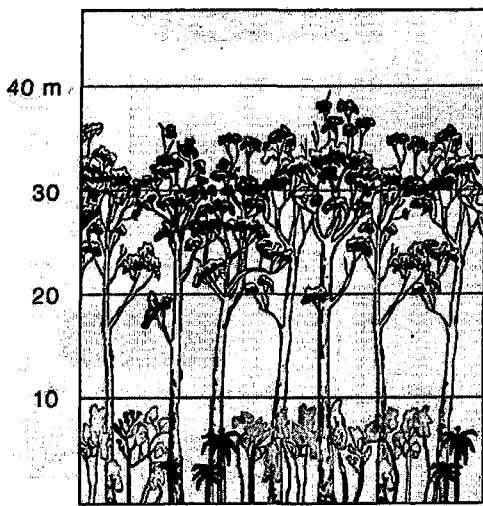

TALL OPEN FOREST A-01

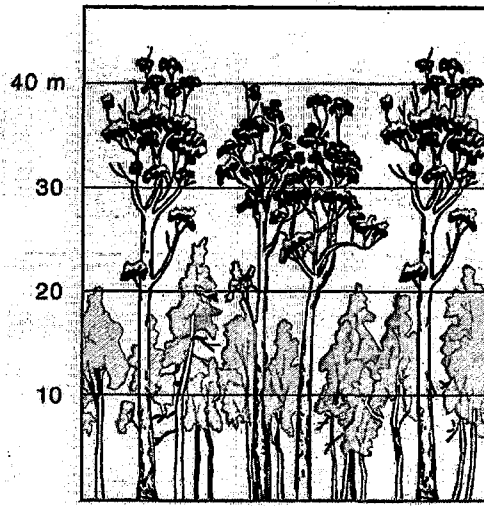

TALL WOODLAND A-02

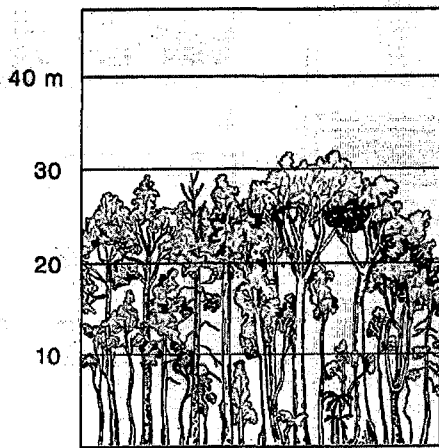

OPEN FOREST A-03

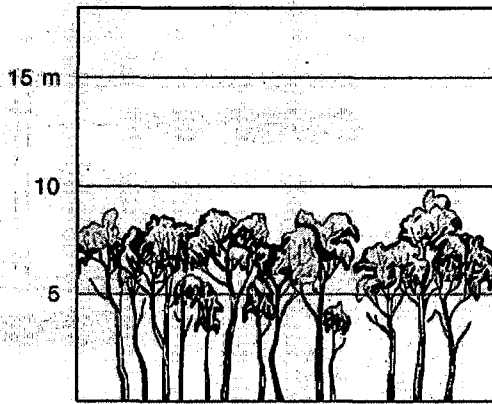

LOW OPEN FOREST A-04

NOTE: See Table 2.3.

FIGURE 2.4(A) CLASSIFICATION OF VEGETATION—FOREST

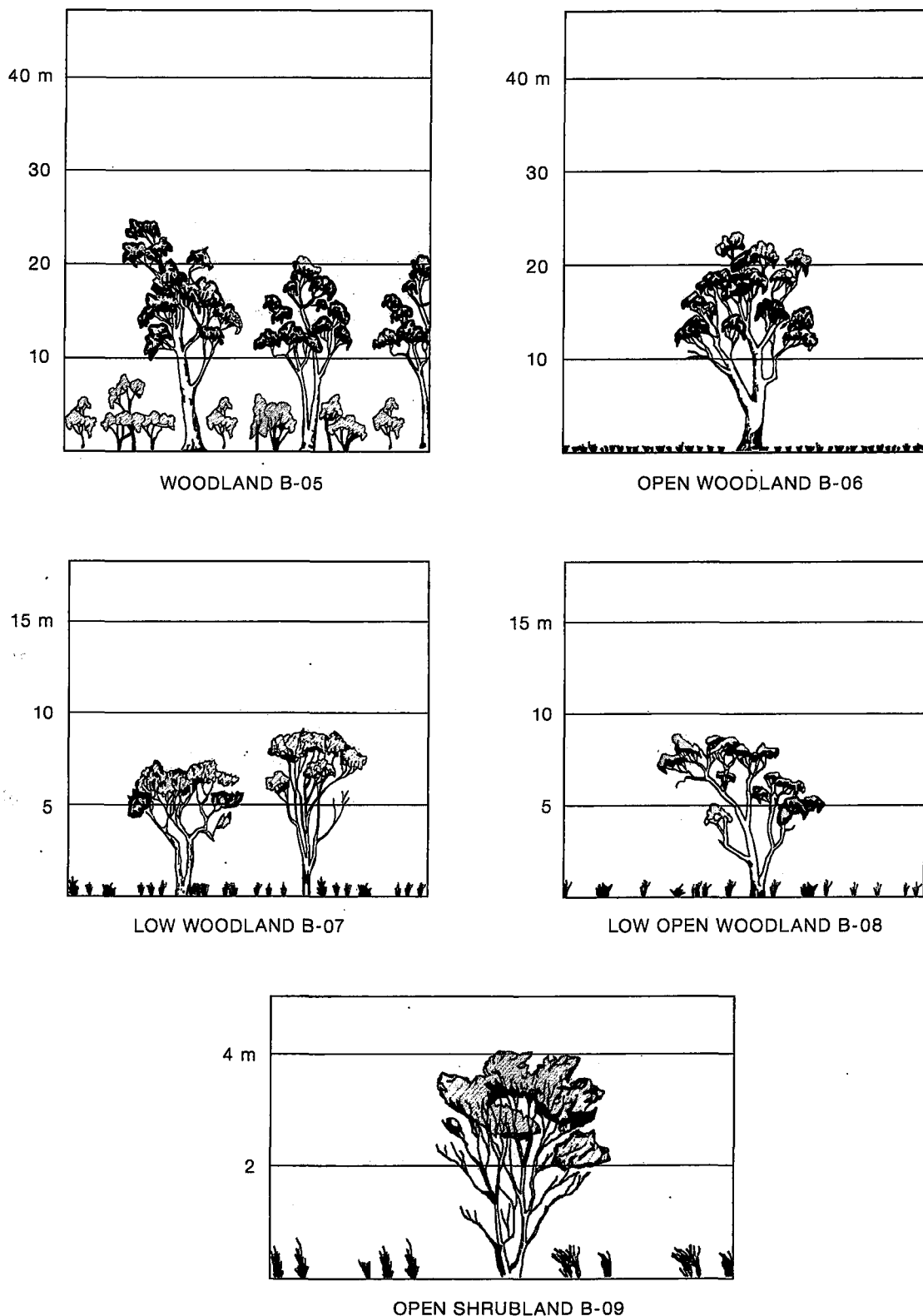

NOTE: See Table 2.3.

FIGURE 2.4(B) CLASSIFICATION OF VEGETATION—WOODLAND

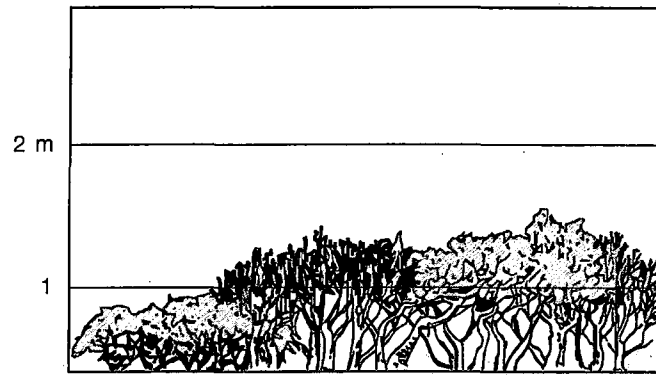

CLOSED HEATH C-10

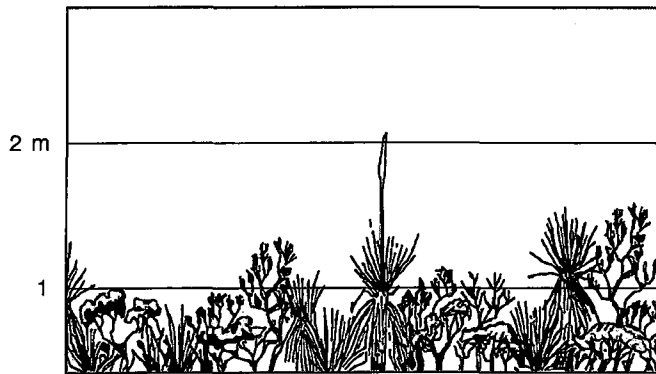

OPEN HEATH C-11

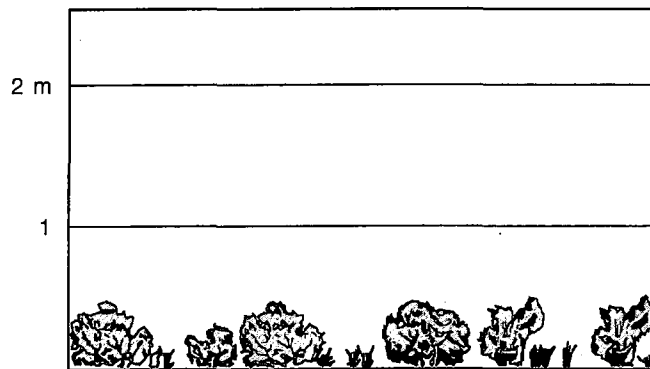

LOW SHRUBLAND C-12

NOTE: See Table 2.3.

FIGURE 2.4(C) CLASSIFICATION OF VEGETATION—SHRUBLAND

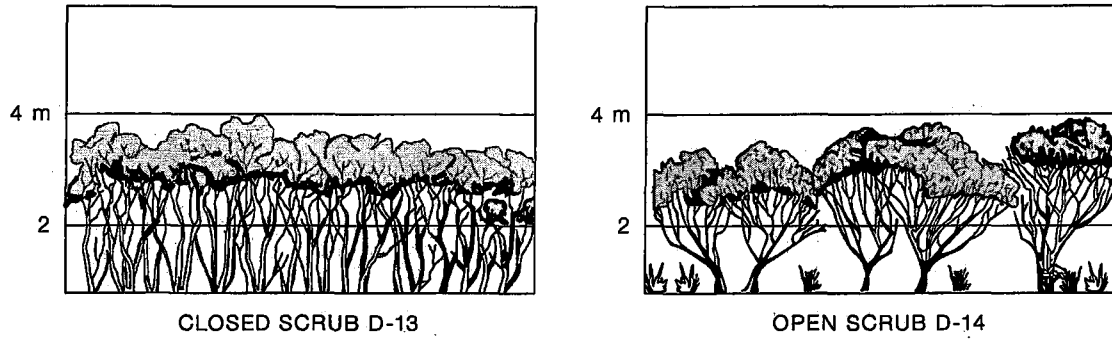

NOTE: See Table 2.3.

FIGURE 2.4(D) CLASSIFICATION OF VEGETATION—SCRUB

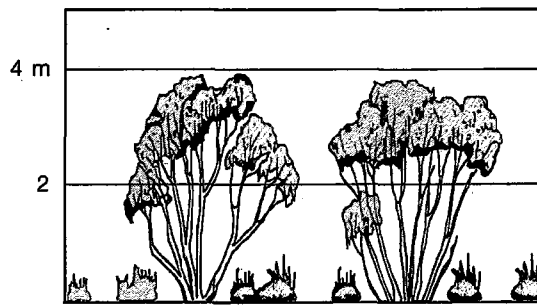

NOTE: See Table 2.3.

FIGURE 2.4(E) CLASSIFICATION OF VEGETATION—MALLEE/MULGA

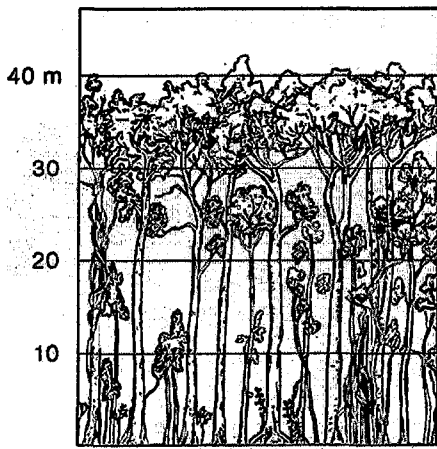

TALL CLOSED FOREST F-16

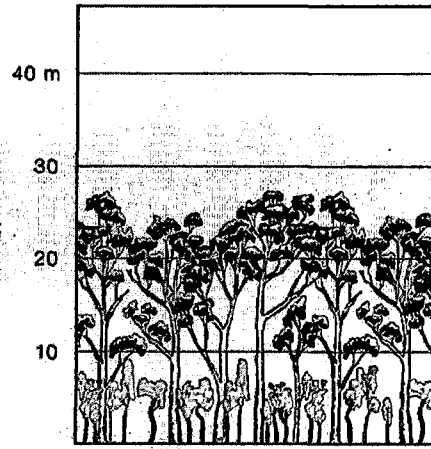

CLOSED FOREST F-17

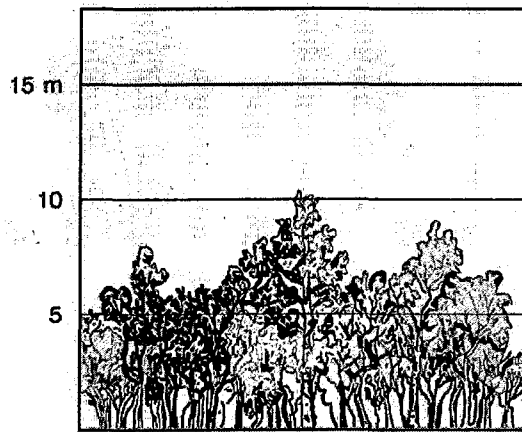

LOW CLOSED FOREST F-18

NOTE: See Table 2.3.

FIGURE 2.4(F) CLASSIFICATION OF VEGETATION—RAINFOREST

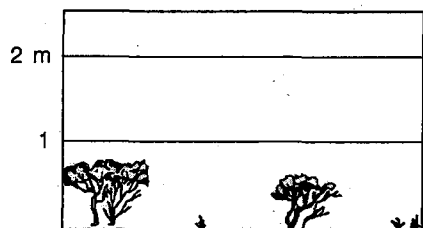

LOW OPEN SHRUBLAND G-19

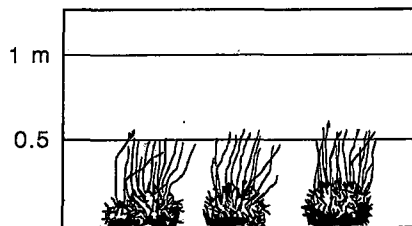

HUMMOCK GRASSLAND G-20

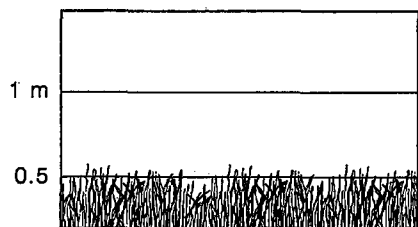

CLOSED TUSSOCK GRASSLAND G-21

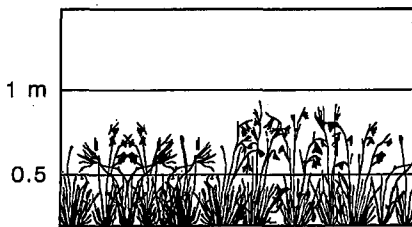

TUSSOCK GRASSLAND G-22

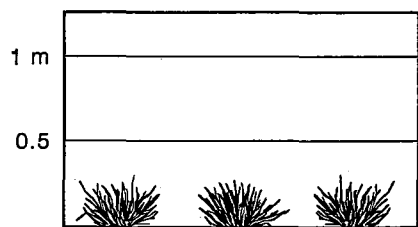

OPEN TUSSOCK G-23

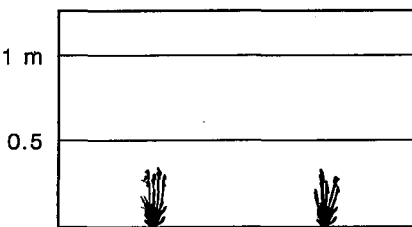

SPARSE OPEN TUSSOCK G-24

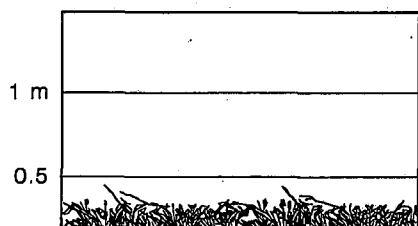

DENSE SOWN PASTURE G-25

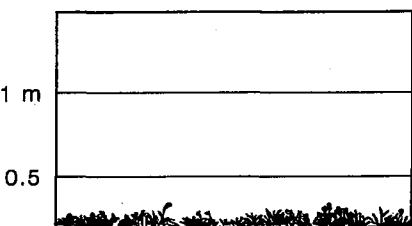

SOWN PASTURE G-26

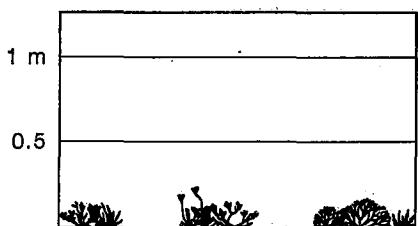

OPEN HERBFIELD G-27

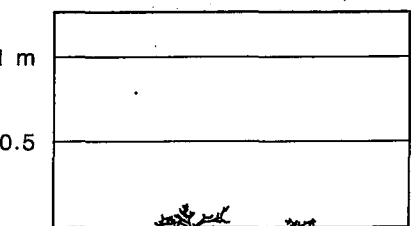

SPARSE OPEN HERBFIELD G-28

NOTE: See Table 2.3.

FIGURE 2.4(G) CLASSIFICATION OF VEGETATION—GRASSLAND (UNMANAGED)

TABLE 2.4.1
INPUT VALUES USED IN MODELLING

Input name	Symbol	Unit	Values used
Vegetation classification	—	—	Refer to Table B2 of Appendix B
Surface fuel/overall fuel	w/W	t/ha	Refer to Table B2 of Appendix B
Vegetation height (shrub and heath)	VH	m	Refer to Table B2 of Appendix B
Fuel age (Tussock moorland)	age	y (years)	20
Fuel moisture factor (Tussock moorland)	Mf	—	5
Heat of combustion	H	kJ/kg	18 600
Fire Danger Index (Forest and Woodlands)	FDI	—	100
			80
			50
			40
Wind speed (Shrub and Heath; Tussock moorland)	V	km/h	45
Ambient temperature	Ta	K	308
Relative humidity	RH	%	25
Effective slope	slope	degrees	All upslopes and flat land (0 degrees) :0
			Downslope >0 to 5 degrees :5
			Downslope >5 to 10 degrees :10
			Downslope >10 to 15 degrees :15
			Downslope >15 to 20 degrees :20
Site slope	θ	degrees	Assumed to be same as effective slope for developing the prescriptive tables
Flame width	W_f	m	100
Flame emissivity	ϵ	—	0.95
Flame temperature	T	K	1090
Flame angle	α	degrees	Determined by the algorithm shown in Appendix B
Elevation of receiver	h	m	$h = 0.5L_f \sin \alpha - d \tan \theta$ if $0.5L_f \sin \alpha > d \tan \theta$ $h = 0$ if $0.5L_f \sin \alpha \leq d \tan \theta$
Path length	L	m	$L = 0$ if $d \leq 0.5L_f \cos \alpha$, otherwise $L = d - 0.5L_f \cos \alpha$
Radiant heat exposure level	R_{ah}	kW/m ²	BAL—LOW BAL—12.5 BAL—19 BAL—29 BAL—40 BAL—FZ

TABLE 2.4.2
DETERMINATION OF BUSHFIRE ATTACK LEVEL (BAL)—FDI 100 (1090 K)

Vegetation classification	Bushfire Attack Levels (BALs)				
	BAL—FZ	BAL—40	BAL—29	BAL—19	BAL—12.5
	Distance (m) of the site from the predominant vegetation class				
	All upslopes and flat land (0 degrees)				
A. Forest	<19	19—<25	25—<35	35—<48	48—<100
B. Woodland	<12	12—<16	16—<24	24—<33	33—<100
C. Shrubland	<10	10—<13	13—<19	19—<27	27—<100
D. Scrub	<7	7—<9	9—<13	13—<19	19—<100
E. Mallee/Mulga	<6	6—<8	8—<12	12—<17	17—<100
F. Rainforest	<8	8—<11	11—<16	16—<23	23—<100
	Downslope >0 to 5 degrees				
A. Forest	<24	24—<32	32—<43	43—<57	57—<100
B. Woodland	<15	15—<21	21—<29	29—<41	41—<100
C. Shrubland	<11	11—<15	15—<22	22—<31	31—<100
D. Scrub	<7	7—<10	10—<15	15—<22	22—<100
E. Mallee/Mulga	<7	7—<9	9—<13	13—<20	20—<100
F. Rainforest	<10	10—<14	14—<20	20—<29	29—<100
	Downslope >5 to 10 degrees				
A. Forest	<31	31—<39	39—<53	53—<69	69—<100
B. Woodland	<20	20—<26	26—<37	37—<50	50—<100
C. Shrubland	<12	12—<17	17—<24	24—<35	35—<100
D. Scrub	<8	8—<11	11—<17	17—<25	25—<100
E. Mallee/Mulga	<7	7—<10	10—<15	15—<23	23—<100
F. Rainforest	<13	13—<18	18—<26	26—<36	36—<100
	Downslope >10 to 15 degrees				
A. Forest	<39	39—<49	49—<64	64—<82	82—<100
B. Woodland	<25	25—<33	33—<45	45—<60	60—<100
C. Shrubland	<14	14—<19	19—<28	28—<39	39—<100
D. Scrub	<9	9—<13	13—<19	19—<28	28—<100
E. Mallee/Mulga	<8	8—<11	11—<18	18—<26	26—<100
F. Rainforest	<17	17—<23	23—<33	33—<45	45—<100
	Downslope >15 to 20 degrees				
A. Forest	<50	50—<61	61—<78	78—<98	98—<100
B. Woodland	<32	32—<41	41—<56	56—<73	73—<100
C. Shrubland	<15	15—<21	21—<31	31—<43	43—<100
D. Scrub	<10	10—<15	15—<22	22—<31	31—<100
E. Mallee/Mulga	<9	9—<13	13—<20	20—<29	29—<100
F. Rainforest	<22	22—<29	29—<42	42—<56	56—<100

TABLE 2.4.3
DETERMINATION OF BUSHFIRE ATTACK LEVEL (BAL)—FDI 80 (1090 K)

Vegetation classification	Bushfire Attack Levels (BALs)				
	BAL—FZ	BAL—40	BAL—29	BAL—19	BAL—12.5
	Distance (m) of the site from the predominant vegetation class				
	All upslopes and flat land (0 degrees)				
A. Forest	<16	16—<21	21—<31	31—<42	42—<100
B. Woodland	<10	10—<14	14—<20	20—<29	29—<100
C. Shrubland	<10	10—<13	13—<19	19—<27	27—<100
D. Scrub	<7	7—<9	9—<13	13—<19	19—<100
E. Mallee/Mulga	<6	6—<8	8—<12	12—<17	17—<100
F. Rainforest	<6	6—<9	9—<13	13—<19	19—<100
	Downslope >0 to 5 degrees				
A. Forest	<20	20—<27	27—<37	37—<50	50—<100
B. Woodland	<13	13—<17	17—<25	25—<35	35—<100
C. Shrubland	<11	11—<15	15—<22	22—<31	31—<100
D. Scrub	<7	7—<10	10—<15	15—<22	22—<100
E. Mallee/Mulga	<7	7—<9	9—<13	13—<20	20—<100
F. Rainforest	<8	8—<11	11—<17	17—<24	24—<100
	Downslope >5 to 10 degrees				
A. Forest	<26	26—<33	33—<46	46—<61	61—<100
B. Woodland	<16	16—<22	22—<31	31—<43	43—<100
C. Shrubland	<12	12—<17	17—<24	24—<35	35—<100
D. Scrub	<8	8—<11	11—<17	17—<25	25—<100
E. Mallee/Mulga	<7	7—<10	10—<15	15—<23	23—<100
F. Rainforest	<11	11—<15	15—<22	22—<31	31—<100
	Downslope >10 to 15 degrees				
A. Forest	<33	33—<42	42—<56	56—<73	73—<100
B. Woodland	<21	21—<28	28—<39	39—<53	53—<100
C. Shrubland	<14	14—<19	19—<28	28—<39	39—<100
D. Scrub	<9	9—<13	13—<19	19—<28	28—<100
E. Mallee/Mulga	<8	8—<11	11—<18	18—<26	26—<100
F. Rainforest	<14	14—<19	19—<28	28—<39	39—<100
	Downslope >15 to 20 degrees				
A. Forest	<42	42—<52	52—<68	68—<87	87—<100
B. Woodland	<27	27—<35	35—<48	48—<64	64—<100
C. Shrubland	<15	15—<21	21—<31	31—<43	43—<100
D. Scrub	<10	10—<15	15—<22	22—<31	31—<100
E. Mallee/Mulga	<9	9—<13	13—<20	20—<29	29—<100
F. Rainforest	<18	18—<25	25—<36	36—<48	48—<100

TABLE 2.4.4
DETERMINATION OF BUSHFIRE ATTACK LEVEL (BAL)—FDI 50 (1090 K)

Vegetation classification	Bushfire Attack Levels (BALs)				
	BAL—FZ	BAL—40	BAL—29	BAL—19	BAL—12.5
	Distance (m) of the site from the predominant vegetation class				
	All upslopes and flat land (0 degrees)				
A. Forest	<12	12—<16	16—<23	23—<32	32—<100
B. Woodland	<7	7—<10	10—<15	15—<22	22—<100
C. Shrubland	<10	10—<13	13—<19	19—<27	27—<100
D. Scrub	<7	7—<9	9—<13	13—<19	19—<100
E. Mallee/Mulga	<6	6—<8	8—<12	12—<17	17—<100
F. Rainforest	<5	5—<6	6—<9	9—<14	14—<100
G. Tussock moorland	<7	7—<9	9—<14	14—<20	20—<100
Downslope >0 to 5 degrees					
A. Forest	<14	14—<19	19—<27	27—<38	38—<100
B. Woodland	<9	9—<12	12—<18	18—<26	26—<100
C. Shrubland	<11	11—<15	15—<22	22—<31	31—<100
D. Scrub	<7	7—<10	10—<15	15—<22	22—<100
E. Mallee/Mulga	<7	7—<9	9—<13	13—<20	20—<100
F. Rainforest	<6	6—<8	8—<12	12—<17	17—<100
G. Tussock moorland	<8	8—<10	10—<16	16—<23	23—<100
Downslope >5 to 10 degrees					
A. Forest	<18	18—<24	24—<34	34—<46	46—<100
B. Woodland	<11	11—<15	15—<23	23—<32	32—<100
C. Shrubland	<12	12—<17	17—<24	24—<35	35—<100
D. Scrub	<8	8—<11	11—<17	17—<25	25—<100
E. Mallee/Mulga	<7	7—<10	10—<15	15—<23	23—<100
F. Rainforest	<7	7—<10	10—<15	15—<22	22—<100
G. Tussock moorland	<9	9—<12	12—<18	18—<26	26—<100
Downslope >10 to 15 degrees					
A. Forest	<22	22—<30	30—<41	41—<56	56—<100
B. Woodland	<14	14—<19	19—<28	28—<40	40—<100
C. Shrubland	<14	14—<19	19—<28	28—<39	39—<100
D. Scrub	<9	9—<13	13—<19	19—<28	28—<100
E. Mallee/Mulga	<8	8—<11	11—<18	18—<26	26—<100
F. Rainforest	<9	9—<13	13—<19	19—<28	28—<100
G. Tussock moorland	<10	10—<13	13—<20	20—<29	29—<100
Downslope >15 to 20 degrees					
A. Forest	<28	28—<37	37—<51	51—<67	67—<100
B. Woodland	<18	18—<25	25—<36	36—<48	48—<100
C. Shrubland	<15	15—<21	21—<31	31—<43	43—<100
D. Scrub	<10	10—<15	15—<22	22—<31	31—<100
E. Mallee/Mulga	<9	9—<13	13—<20	20—<29	29—<100
F. Rainforest	<12	12—<17	17—<25	25—<35	35—<100
G. Tussock moorland	<11	11—<15	15—<23	23—<33	33—<100

TABLE 2.4.5
DETERMINATION OF BUSHFIRE ATTACK LEVEL (BAL)—FDI 40 (1090 K)

Vegetation classification	Bushfire Attack Levels (BALs)				
	BAL—FZ	BAL—40	BAL—29	BAL—19	BAL—12.5
	Distance (m) of the site from the predominant vegetation class				
	All upslopes and flat land (0 degrees)				
A. Forest	<10	10—<13	13—<20	20—<28	28—<100
B. Woodland	<6	6—<9	9—<13	13—<19	19—<100
C. Shrubland	<10	10—<13	13—<19	19—<27	27—<100
D. Scrub	<7	7—<9	9—<13	13—<19	19—<100
E. Mallee/Mulga	<6	6—<8	8—<12	12—<17	17—<100
F. Rainforest	<4	4—<5	5—<8	8—<12	12—<100
	Downslope >0 to 5 degrees				
A. Forest	<12	12—<16	16—<24	24—<34	34—<100
B. Woodland	<8	8—<11	11—<16	16—<23	23—<100
C. Shrubland	<11	11—<15	15—<22	22—<31	31—<100
D. Scrub	<7	7—<10	10—<15	15—<22	22—<100
E. Mallee/Mulga	<7	7—<9	9—<13	13—<20	20—<100
F. Rainforest	<5	5—<7	7—<10	10—<15	15—<100
	Downslope >5 to 10 degrees				
A. Forest	<15	15—<20	20—<29	29—<41	41—<100
B. Woodland	<9	9—<13	13—<19	19—<28	28—<100
C. Shrubland	<12	12—<17	17—<24	24—<35	35—<100
D. Scrub	<8	8—<11	11—<17	17—<25	25—<100
E. Mallee/Mulga	<7	7—<10	10—<15	15—<23	23—<100
F. Rainforest	<6	6—<8	8—<13	13—<19	19—<100
	Downslope >10 to 15 degrees				
A. Forest	<19	19—<25	25—<36	36—<49	49—<100
B. Woodland	<12	12—<16	16—<24	24—<35	35—<100
C. Shrubland	<14	14—<19	19—<28	28—<39	39—<100
D. Scrub	<9	9—<13	13—<19	19—<28	28—<100
E. Mallee/Mulga	<8	8—<11	11—<18	18—<26	26—<100
F. Rainforest	<8	8—<11	11—<16	16—<24	24—<100
	Downslope >15 to 20 degrees				
A. Forest	<24	24—<31	31—<44	44—<59	59—<100
B. Woodland	<15	15—<21	21—<31	31—<42	42—<100
C. Shrubland	<15	15—<21	21—<31	31—<43	43—<100
D. Scrub	<10	10—<15	15—<22	22—<31	31—<100
E. Mallee/Mulga	<9	9—<13	13—<20	20—<29	29—<100
F. Rainforest	<10	10—<14	14—<21	21—<30	30—<100

SECTION 3 CONSTRUCTION GENERAL

3.1 GENERAL

This Section specifies general requirements for the construction of buildings for all Bushfire Attack Levels (BALs).

NOTE: There are a number of Standards that specify requirements for construction; however, where this Standard does not provide construction requirements for a particular element, the other Standards apply.

The BALs and the corresponding Sections for specific construction requirements are listed in Table 3.1.

TABLE 3.1
BUSHFIRE ATTACK LEVELS AND CORRESPONDING SECTIONS FOR
SPECIFIC CONSTRUCTION REQUIREMENTS

Bushfire Attack Level (BAL)	Classified vegetation within 100 m of the site and heat flux exposure thresholds	Description of predicted bushfire attack and levels of exposure	Construction Section
BAL—LOW	See Clause 2.2.3.2	There is insufficient risk to warrant specific construction requirements	4
BAL—12.5	$\leq 12.5 \text{ kW/m}^2$	Ember attack	3 and 5
BAL—19	$> 12.5 \text{ kW/m}^2$ $\leq 19 \text{ kW/m}^2$	Increasing levels of ember attack and burning debris ignited by windborne embers together with increasing heat flux	3 and 6
BAL—29	$> 19 \text{ kW/m}^2$ $\leq 29 \text{ kW/m}^2$	Increasing levels of ember attack and burning debris ignited by windborne embers together with increasing heat flux	3 and 7
BAL—40	$> 29 \text{ kW/m}^2$ $\leq 40 \text{ kW/m}^2$	Increasing levels of ember attack and burning debris ignited by windborne embers together with increasing heat flux with the increased likelihood of exposure to flames	3 and 8
BAL—FZ	$> 40 \text{ kW/m}^2$	Direct exposure to flames from fire front in addition to heat flux and ember attack	3 and 9

3.2 CONSTRUCTION REQUIREMENTS FOR SPECIFIC STRUCTURES

3.2.1 Attached structures

Where any part of a garage, carport, veranda or similar roofed structure is attached to, or shares a common roof space with, a building required to comply with this Standard, the entire garage, carport, veranda or similar roofed structure shall comply with the construction requirements of this Standard, as applicable to the subject building.

Alternatively, the structure shall be separated from the subject building by a wall that extends to the underside of a non-combustible roof covering, and that complies with one of the following:

- (a) The wall shall have an FRL of not less than 60/60/60 for loadbearing walls and -/60/60 for non-loadbearing walls when tested from the attached structure side and shall have openings protected as follows:
 - (i) Doorways—by FRL -/60/30 self-closing fire doors.

(ii) Windows—by FRL $-/60/-$ fire windows permanently fixed in the closed position.

(iii) Other openings—by construction with an FRL not less than $-/60/-$.

NOTE: Control and construction joints, subfloor vents, weepholes and penetrations for pipes and conduits need not comply with the above [Item (iii)].

or

(b) The wall shall be of masonry, earth wall or masonry-veneer construction with the masonry leaf of not less than 90 mm in thickness and shall have openings protected as follows:

(i) Doorways—by FRL $-/60/30$ self-closing fire doors.

(ii) Windows—by FRL $-/60/-$ fire windows permanently fixed in the closed position.

(iii) Other openings—by construction with an FRL not less than $-/60/-$.

NOTE: Control and construction joints, subfloor vents, weepholes and penetrations for pipes and conduits need not comply with the above [Item (iii)].

3.2.2 Garages and carports below the subject building

Where a garage or carport is below a building required to comply with this Standard, it shall comply with the construction requirements of this Standard, as applicable to the subject building.

Alternatively, any construction separating the garage or carport (including walls and flooring systems) from the remainder of the building shall comply with one of the following:

(a) The separating construction shall have an FRL of not less than 60/60/60 for loadbearing construction and $-/60/60$ for non-loadbearing construction when tested from the garage or carport side and shall have openings protected in accordance with the following:

(i) Doorways—by $-/60/30$ self-closing fire doors.

(ii) Windows—by $-/60/-$ fire windows permanently fixed in the closed position.

(iii) Other openings—by construction with an FRL not less than $-/60/-$.

NOTE: Control and construction joints, subfloor vents, weepholes and penetrations for pipes and conduits need not comply with the above [Item (iii)].

or

(b) Where part or all of the separating construction is a wall, the wall need not comply with Item (a) above, provided the wall is of masonry, earth wall or masonry-veneer construction with the masonry leaf of not less than 90 mm in thickness and the wall has openings protected in accordance with the following:

(i) Doorways—by $-/60/30$ self-closing fire doors.

(ii) Windows—by $-/60/-$ fire windows permanently fixed in the closed position.

(iii) Other openings—by construction with an FRL not less than $-/60/-$.

NOTE: Control and construction joints, subfloor vents, weepholes and penetrations for pipes and conduits need not comply with the above [Item (iii)].

3.2.3 Adjacent structures

Where any garage, carport, or similar roofed structure is not attached to a building required to comply with this Standard, the entire garage, carport, or similar roofed structure on the subject allotment shall comply with the construction requirements of this Standard.

Alternatively, the adjacent structure shall be separated from the subject building by one of the following:

- (a) A distance of not less than 6 m from the building required to comply with this Standard.

or

- (b) A wall that extends to the underside of a non-combustible roof covering and has an FRL of not less than 60/60/60 for loadbearing walls and -/60/60 for non-loadbearing walls when tested from the attached structure side. Any openings in the wall shall be protected in accordance with the following:

- (i) Doorways—by FRL -/60/30 self-closing fire doors.
(ii) Windows—by FRL -/60/- fire windows permanently fixed in the closed position.
(iii) Other openings—by construction with an FRL not less than -/60/-.

NOTE: Control and construction joints, subfloor vents, weepholes and penetrations for pipes and conduits need not comply with the above [Item (iii)].

or

- (c) A wall that extends to the underside of a non-combustible roof covering and is of masonry, earth wall or masonry-veneer construction with the masonry leaf of not less than 90 mm in thickness. Any openings in the wall shall be protected in accordance with the following:

- (i) Doorways—by FRL -/60/30 self-closing fire doors.
(ii) Windows—by FRL -/60/- fire windows permanently fixed in the closed position.
(iii) Other openings—by construction with an FRL not less than -/60/-.

NOTE: Control and construction joints, subfloor vents, weepholes and penetrations for pipes and conduits need not comply with the above [Item (iii)].

3.3 EXTERNAL MOULDINGS

Unless otherwise required in Sections 4 to 9, combustible external mouldings, jointing strips, trims and sealants may be used for decorative purposes or to cover joints between sheeting material.

3.4 HIGHER LEVELS OF CONSTRUCTION

Construction requirements specified for a particular Bushfire Attack Level (BAL) shall be acceptable for a lower level. For example, if the site has been assessed at BAL—12.5, BAL—12.5 construction is required; however any element or combination of elements contained BAL—19, BAL—29, BAL—40 and BAL—FZ levels of construction may be used to satisfy this Standard.

3.5 REDUCTION IN CONSTRUCTION REQUIREMENTS DUE TO SHIELDING

The construction requirements for the next lower BAL than that determined for the site may be applied to an elevation of the building where the elevation is not exposed to the source of bushfire attack. An elevation is deemed to be not exposed to the source of bushfire attack if all of the straight lines between that elevation and the source of bushfire attack are obstructed by another part of the building (see Figure 3.1).

The construction requirements for a shielded elevation shall be not less than that required for BAL—12.5, except where the exposed elevations have been determined as BAL—LOW.

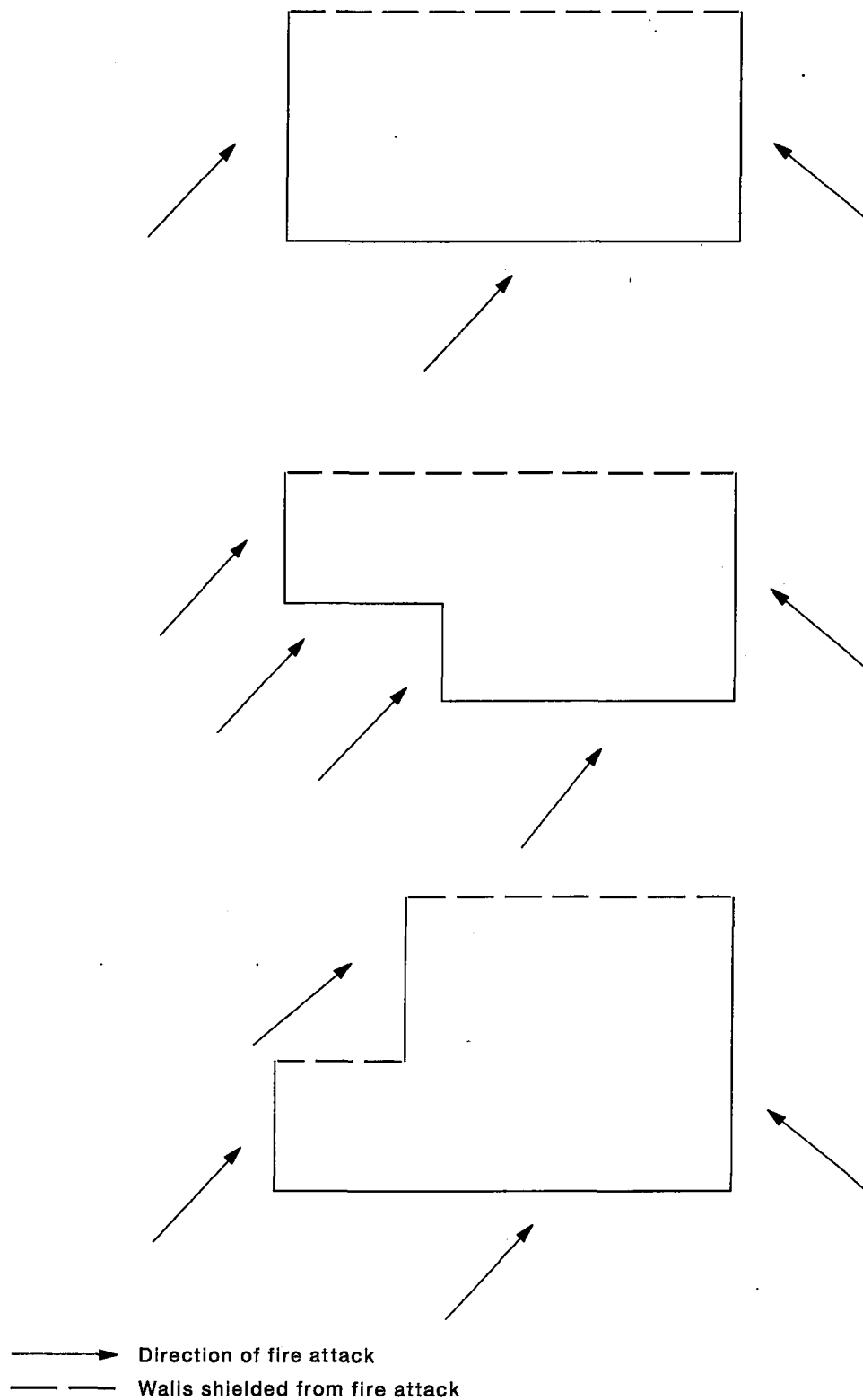

FIGURE 3.1 EXAMPLES OF WALLS SUBJECT TO SHIELDING

3.6 VENTS, WEEPHOLES AND GAPS

Where a circular probe of 3 mm diameter is capable of being passed through external vents, weepholes or gaps, the vents, weepholes and gaps shall be screened as specified in Sections 3, 5, 6, 7, 8 and 9, except for weepholes from the frames of windows and glazed doors.

To determine the maximum aperture size of screening material, it shall not be possible to pass a circular probe of 2 mm diameter through the aperture.

Gaps between doors and the door jambs, heads or sills (thresholds) shall be as shown in Figure 3.2. Alternatively, gaps shall be protected by draught excluders.

C3.6 Weepholes from the frames of windows and glazed doors and those gaps between doors and door jambs, heads or sills (thresholds) that may exceed 3 mm (see Figure 3.2) are exempt from screening because they do not provide a direct passage for embers to the interior of the building or building cavity.

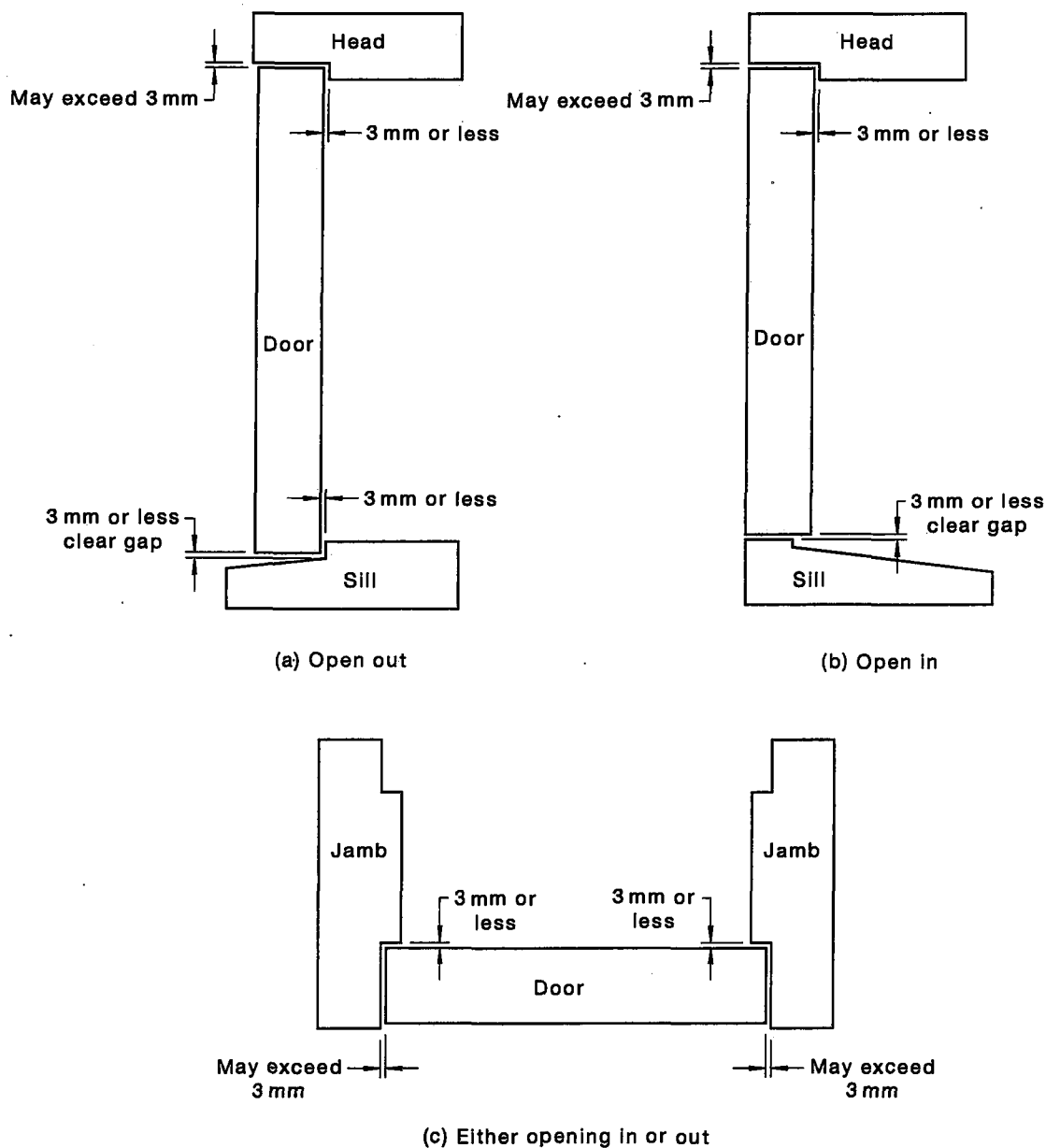

FIGURE 3.2 GAPS BETWEEN DOORS AND THE DOOR JAMBS, HEADS OR SILLS (THRESHOLDS)

3.7 BUSHFIRE SHUTTERS

Bushfire shutters shall—

- (a) be fixed to the building and be non-removable;
- (b) when in the closed position, have no gap greater than 3 mm between the shutter and the wall, the sill or the head;
- (c) be readily manually operable from either inside or outside;
- (d) protect the entire window assembly or door assembly;
- (e) consist of materials specified in Clauses 5.5.1, 6.5.1, 7.5.1, 8.5.1 and 9.5.1 for the relevant BAL; and



- (f) where perforated, have—
- (i) uniformly distributed perforations with a maximum aperture of 3 mm when the shutter is providing radiant heat protection or 2 mm when the shutter is also providing ember protection (such as where the openable portion of the window is not screened in accordance with the requirements of the respective BAL); and
 - (ii) a perforated area no greater than 20% of the shutter.

If bushfire shutters are fitted to all external doors then at least one of those shutters shall be operable from the inside to facilitate safe egress from the building.

3.8 TESTING TO AS 1530.8

Where any material, element of construction or system satisfies the test criteria of AS 1530.8.1, for any BAL (BAL—12.5 to BAL—40) and AS 1530.8.2 (BAL—FZ) it satisfies the requirements of that BAL.

If any material, element of construction or system satisfies the test criteria without screening for ember protection, the requirements of this Standard for screening of openable parts of windows or doors shall still apply.

3.9 GLAZING

Glazing requirements shall be in accordance with Sections 5 to 9 of this Standard.

See AS 1288 for an explanation of the terminologies used to describe various types of glass in this Standard.

SECTION 4 CONSTRUCTION FOR BUSHFIRE ATTACK LEVEL LOW (BAL—LOW)

This Standard does not provide construction requirements for buildings assessed in bushfire-prone areas in accordance with Section 2 as being BAL—LOW.

NOTE: There are a number of Standards that specify requirements for construction; however, where this Standard does not provide construction requirements for a particular element, the other Standards apply.

The Bushfire Attack Level BAL—LOW is based on insufficient risk to warrant specific bushfire construction requirements. It is predicated on low threat vegetation and non-vegetated areas (see Clause 2.2.3.2).

SECTION 5 CONSTRUCTION FOR BUSHFIRE ATTACK LEVEL 12.5 (BAL—12.5)

5.1 GENERAL

A building assessed in Section 2 as being BAL—12.5 shall comply with Section 3 and Clauses 5.2 to 5.8.

NOTE: There are a number of Standards that specify requirements for construction; however, where this Standard does not provide construction requirements for a particular element, the other Standards apply.

Any element of construction or system that satisfies the test criteria of AS 1530.8.1 may be used in lieu of the applicable requirements contained in Clauses 5.2 to 5.8 (see Clause 3.8).

NOTE: BAL—12.5 is primarily concerned with protection from ember attack and radiant heat up to and including 12.5 kW/m^2 where the site is less than 100 m from the source of bushfire attack.

5.2 SUBFLOOR SUPPORTS

This Standard does not provide construction requirements for subfloor support posts, columns, stumps, piers and poles.

NOTE: The exclusion of requirements for subfloor supports applies to the principal building only and not to verandas, decks, steps, ramps and landings (see Clause 5.7).

C5.2 Ideally, storage of combustible materials beneath a floor at this BAL would not occur and on this assumption, there is no requirement to enclose the subfloor space or to protect flooring materials from bushfire attack. However, should combustible materials be stored, it is recommended the area be protected as materials stored in the subfloor space may be ignited by embers and cause an impact to the building.

5.3 FLOORS

5.3.1 Concrete slabs on ground

This Standard does not provide construction requirements for concrete slabs on the ground.

5.3.2 Elevated floors

This Standard does not provide construction requirements for elevated floors, including bearers, joists and flooring.

5.4 EXTERNAL WALLS

5.4.1 Walls

That part of an external wall surface that is less than 400 mm from the ground or less than 400 mm above decks, carport roofs, awnings and similar elements or fittings having an angle less than 18 degrees to the horizontal and extending more than 110 mm in width from the wall (see Figure D3, Appendix D) shall be of—

- (a) non-combustible material; *or*
- (b) fibre-cement external cladding, a minimum of 6 mm in thickness; *or*
- (c) bushfire-resisting timber (see Appendix F); *or*
- (d) a timber species as specified in Paragraph E1 and listed in Table E1, Appendix E; *or*
- (e) a combination of any of Items (a), (b), (c) or (d) above.

There are no requirements for external wall surfaces 400 mm or more from the ground or for external wall surfaces 400 mm or more above decks, carport roofs, awnings and similar elements or fittings having an angle less than 18 degrees to the horizontal and extending more than 110 mm in width from the wall (see Figure D3, Appendix D).

5.4.2 Joints

All joints in the external surface material of walls shall be covered, sealed, overlapped, backed or butt-jointed to prevent gaps greater than 3 mm.

Alternatively, sarking-type material may be applied over the outer face of the frame prior to fixing any external cladding.

5.4.3 Vents and weepholes

Vents and weepholes in external walls shall be screened with a mesh with a maximum aperture of 2 mm, made of corrosion-resistant steel, bronze or aluminium, except where the vents and weepholes are less than 3 mm (see Clause 3.6), or are located in an external wall of a subfloor space.

5.5 EXTERNAL GLAZED ELEMENTS AND ASSEMBLIES AND EXTERNAL DOORS

5.5.1 Bushfire shutters

Where fitted, bushfire shutters shall comply with Clause 3.7 and be made from—

- (a) non-combustible material; *or*
- (b) a timber species as specified in Paragraph E1 and listed in Table E1, Appendix E; *or*
- (c) bushfire-resisting timber (see Appendix F); *or*
- (d) a combination of any of Items (a), (b) or (c) above.

5.5.2 Windows

Window assemblies shall comply with one of the following:

- (a) They shall be completely protected by a bushfire shutter that complies with Clause 5.5.1.
or
- (b) They shall be completely protected externally by screens with a mesh with a maximum aperture of 2 mm, made of corrosion-resistant steel, bronze or aluminium.
or
- (c) They shall comply with the following:
 - (i) For window assemblies less than 400 mm from the ground or less than 400 mm above decks, carport roofs, awnings and similar elements or fittings having an angle less than 18 degrees to the horizontal and extending more than 110 mm in width from the window frame (see Figure D3, Appendix D), window frames and window joinery shall be made from one of the following:
 - (A) Bushfire-resisting timber (see Appendix F).
or
 - (B) A timber species specified in Paragraph E2 and listed in Table E2, Appendix E.
or
 - (C) Metal.
or

- (D) Metal-reinforced PVC-U. The reinforcing members shall be made from aluminium, stainless steel, or corrosion-resistant steel and the frame and sash shall satisfy the design load, performance and structural strength of the member.
- (ii) Externally fitted hardware that supports the sash in its functions of opening and closing shall be metal.
- (iii) Where glazing is less than 400 mm from the ground or less than 400 mm above decks, carport roofs, awnings and similar elements or fittings having an angle less than 18 degrees to the horizontal and extending more than 110 mm in width from the window frame (see Figure D3, Appendix D), the glazing shall be Grade A safety glass minimum 4 mm, or glass blocks with no restriction on glazing methods.
- NOTE: Where double glazed units are used the above requirements apply to the external face of the window assembly only.
- (iv) Where glazing is other than that specified in Item (iii) above, annealed glass may be used.
- (v) The openable portions of windows shall be screened with mesh with a maximum aperture of 2 mm, made of corrosion-resistant steel, bronze or aluminium.

5.5.3 Doors—Side-hung external doors (including French doors, panel fold and bi-fold doors)

Side-hung external doors, including French doors, panel fold and bi-fold doors, shall comply with one of the following:

- (a) They shall be protected by a bushfire shutter that complies with Clause 5.5.1.
- or*
- (b) They shall be completely protected externally by screens with a mesh with a maximum aperture of 2 mm, made of corrosion-resistant steel, bronze or aluminium.
- or*
- (c) They shall comply with the following:
- (i) Doors shall be—
- (A) non-combustible; *or*
- (B) a solid timber door, having a minimum thickness of 35 mm for the first 400 mm above the threshold; *or*
- (C) a door, including a hollow core door, with a non-combustible kickplate on the outside for the first 400 mm above the threshold; *or*
- (D) a fully framed glazed door, where the framing is made from materials required for bushfire shutters (see Clause 5.5.1), or from a timber species specified in Paragraph E2 and listed in Table E2, Appendix E.
- (ii) Where doors incorporate glazing, the glazing shall comply with the glazing requirements for windows.
- (iii) Doors shall be tight-fitting to the doorframe and to an abutting door, if applicable.

- (iv) Where any part of the door assembly is less than 400 mm from the ground or less than 400 mm above decks, carport roofs, awnings and similar elements or fittings having an angle less than 18 degrees to the horizontal and extending more than 110 mm in width from the door (see Figure D3, Appendix D), that part of the door assembly shall be made from one of the following:
- (A) Bushfire-resisting timber (see Appendix F).
or
 - (B) A timber species specified in Paragraph E2 and listed in Table E2, Appendix E.
or
 - (C) Metal.
or
 - (D) Metal-reinforced PVC-U. The reinforcing members shall be made from aluminium, stainless steel, or corrosion-resistant steel and the door assembly shall satisfy the design load, performance and structural strength of the member.
- (v) Weather strips, draught excluders or draught seals shall be installed at the base of side-hung external doors.

5.5.4 Doors—Sliding doors

Sliding doors shall comply with one of the following:

- (a) They shall be protected by a bushfire shutter that complies with Clause 5.5.1.
or
- (b) They shall be completely protected externally by screens with a mesh with a maximum aperture of 2 mm, made of corrosion-resistant steel, bronze or aluminium.
or
- (c) They shall comply with the following:
 - (i) Any glazing incorporated in sliding doors shall be Grade A safety glass complying with AS 1288.
 - (ii) There is no requirement to screen the openable part of the sliding door. However, if screened, the screens shall be a mesh or perforated sheet made of corrosion-resistant steel, bronze or aluminium.

NOTE: The construction of manufactured sliding doors should prevent the entry of embers when the door is closed. There is no requirement to provide screens to the openable part of these doors as it is assumed that a sliding door will be closed if occupants are not present or during a bushfire event. Screens of materials other than those specified may not resist ember attack.
 - (iii) Sliding doors shall be tight-fitting in the frames.

5.5.5 Doors—Vehicle access doors (garage doors)

The following apply to vehicle access doors:

- (a) The lower portion of a vehicle access door that is within 400 mm of the ground when the door is closed (see Figure D4, Appendix D) shall be made from—
 - (i) non-combustible material; *or*
 - (ii) bushfire-resisting timber (see Appendix F); *or*
 - (iii) fibre-cement sheet, a minimum of 6 mm in thickness; *or*

- (iv) a timber species specified in Paragraph E1 and listed in Table E1, Appendix E;
or
- (v) a combination of any of Items (i), (ii), (iii) or (iv) above.
- (b) Panel lift, tilt doors or side-hung doors shall be fitted with suitable weather strips, draught excluders, draught seals or guide tracks, as appropriate to the door type, with a maximum gap no greater than 3 mm.
- (c) Roller doors shall have guide tracks with a maximum gap no greater than 3 mm and shall be fitted with a nylon brush that is in contact with the door (see Figure D4, Appendix D).
- (d) Vehicle access doors shall not include ventilation slots.

5.6 ROOFS (INCLUDING VERANDA AND ATTACHED CARPORT ROOFS, PENETRATIONS, EAVES, FASCIAS, GABLES, GUTTERS AND DOWNPIPES)

5.6.1 General

The following apply to all types of roofs and roofing systems:

- (a) Roof tiles, roof sheets and roof-covering accessories shall be non-combustible.
- (b) The roof/wall junction shall be sealed, to prevent openings greater than 3 mm, either by the use of fascia and eaves linings or by sealing between the top of the wall and the underside of the roof and between the rafters at the line of the wall.
- (c) Roof ventilation openings, such as gable and roof vents, shall be fitted with ember guards made of non-combustible material or a mesh or perforated sheet with a maximum aperture of 2 mm, made of corrosion-resistant steel, bronze or aluminium.

5.6.2 Tiled roofs

Tiled roofs shall be fully sarked. The sarking shall—

- (a) have a flammability index of not more than 5;
- (b) be located directly below the roof battens;
- (c) cover the entire roof area including the ridge; and
- (d) be installed so that there are no gaps that would allow the entry of embers where the sarking meets fascias, gutters, valleys and the like.

5.6.3 Sheet roofs

Sheet roofs shall—

- (a) be fully sarked in accordance with Clause 5.6.2, except that foil-backed insulation blankets may be installed over the battens;
or
- (b) have any gaps greater than 3 mm, under corrugations or ribs of sheet roofing and between roof components, sealed at the fascia or wall line and at valleys, hips and ridges by—
 - (i) a mesh or perforated sheet with a maximum aperture of 2 mm, made of corrosion-resistant steel, bronze or aluminium; *or*
 - (ii) mineral wool; *or*
 - (iii) other non-combustible material; *or*
 - (iv) a combination of any of Items (i), (ii) or (iii) above.

5.6.4 Veranda, carport and awning roofs

The following apply to veranda, carport and awning roofs:

- (a) A veranda, carport or awning roof forming part of the main roof space [see Figure D1(a), Appendix D] shall meet all the requirements for the main roof, as specified in Clauses 5.6.1, 5.6.2, 5.6.3, 5.6.5 and 5.6.6.
- (b) A veranda, carport or awning roof separated from the main roof space by an external wall [see Figures D1(b) and D1(c), Appendix D] complying with Clause 5.4 shall have a non-combustible roof covering.

NOTE: There is no requirement to line the underside of a veranda, carport or awning roof that is separated from the main roof space.

5.6.5 Roof penetrations

The following apply to roof penetrations:

- (a) Roof penetrations, including roof lights, roof ventilators, roof-mounted evaporative cooling units, aerials, vent pipes and supports for solar collectors, shall be adequately sealed at the roof to prevent gaps greater than 3 mm. The material used to seal the penetration shall be non-combustible.
- (b) Openings in vented roof lights, roof ventilators or vent pipes shall be fitted with ember guards made from a mesh or perforated sheet with a maximum aperture of 2 mm, made of corrosion-resistant steel, bronze or aluminium.
- (c) All overhead glazing shall be Grade A laminated safety glass complying with AS 1288.
- (d) Glazed elements in roof lights and skylights may be of polymer provided a Grade A safety glass diffuser, complying with AS 1288, is installed under the glazing. Where glazing is an insulating glazing unit (IGU), Grade A toughened safety glass, minimum 4 mm, shall be used in the outer pane of the IGU.
- (e) Flashing elements of tubular skylights may be of a fire-retardant material, provided the roof integrity is maintained by an under-flashing of a material having a flammability index no greater than 5.
- (f) Evaporative cooling units shall be fitted with butterfly closers at or near the ceiling level or, the unit shall be fitted with non-combustible covers with a mesh or perforated sheet with a maximum aperture of 2 mm, made of corrosion-resistant steel, bronze or aluminium.
- (g) Vent pipes made from PVC are permitted.

5.6.6 Eaves linings, fascias and gables

The following apply to eaves linings, fascias and gables:

- (a) Gables shall comply with Clause 5.4.
- (b) Eaves penetrations shall be protected the same as for roof penetrations, as specified in Clause 5.6.5.
- (c) Eaves ventilation openings greater than 3 mm shall be fitted with ember guards made of non-combustible material or a mesh or perforated sheet with a maximum aperture of 2 mm, made of corrosion-resistant steel, bronze or aluminium.

Joints in eaves linings, fascias and gables may be sealed with plastic joining strips or timber storm moulds.

This Standard does not provide construction requirements for fascias, bargeboards and eaves linings.

5.6.7 Gutters and downpipes

This Standard does not provide material requirements for—

- (a) gutters, with the exception of box gutters; and
- (b) downpipes.

If installed, gutter and valley leaf guards shall be non-combustible.

Box gutters shall be non-combustible and flashed at the junction with the roof with non-combustible material.

5.7 VERANDAS, DECKS, STEPS, RAMPS AND LANDINGS

5.7.1 General

Decking shall be either spaced or continuous (i.e., without spacing).

There is no requirement to enclose the subfloor spaces of verandas, decks, steps, ramps or landings.

C5.7.1 Spaced decking is nominally spaced at 3 mm (in accordance with standard industry practice); however, due to the nature of timber decking with seasonal changes in moisture content, that spacing may range from 0–5 mm during service. The preferred dimension for gaps is 3 mm (which is in line with other 'permissible gaps') in other parts of this Standard. It should be noted that recent research studies have shown that gaps at 5 mm spacing afford opportunity for embers to become lodged in between timbers, which may contribute to a fire. Larger gap spacings of 10 mm may preclude this from happening but such a spacing regime may not be practical for a timber deck.

5.7.2 Enclosed subfloor spaces of verandas, decks, steps, ramps and landings

5.7.2.1 Materials to enclose a subfloor space

This Standard does not provide construction requirements for the materials used to enclose a subfloor space except where those materials are less than 400 mm from the ground.

Where the materials used to enclose a subfloor space are less than 400 mm from the ground, they shall comply with Clause 5.4.

5.7.2.2 Supports

This Standard does not provide construction requirements for support posts, columns, stumps, stringers, piers and poles.

5.7.2.3 Framing

This Standard does not provide construction requirements for the framing of verandas, decks, ramps or landings (i.e., bearers and joists).



5.7.2.4 Decking

This Standard does not provide construction requirements for decking that is more than 300 mm from a glazed element.

Decking less than 300 mm (measured horizontally at deck level) from glazed elements that are less than 400 mm (measured vertically) from the surface of the deck (see Figure D2, Appendix D) shall be made from—

- (a) non-combustible material; *or*
- (b) bushfire-resisting timber (see Appendix F); *or*
- (c) a timber species, as specified in Paragraph E1 and listed in Table E1 of Appendix E;
- (d) PVC-U; *or*
- (e) a combination of any of Items (a), (b), (c) or (d) above.

5.7.3 Unenclosed subfloor spaces of verandas, decks, steps, ramps and landings

5.7.3.1 Supports

This Standard does not provide construction requirements for support posts, columns, stumps, stringers, piers and poles.

5.7.3.2 Framing

This Standard does not provide construction requirements for the framing of verandas, decks, ramps or landings (i.e., bearers and joists).

5.7.3.3 Decking

This Standard does not provide construction requirements for decking unless it is less than 300 mm from a glazed element.

Decking less than 300 mm (measured horizontally at deck level) from glazed elements that are less than 400 mm (measured vertically) from the surface of the deck (see Figure D2, Appendix D) shall be made from—

- (a) non-combustible material; *or*
- (b) bushfire-resisting timber (see Appendix F); *or*
- (c) a timber species, as specified in Paragraph E1 and listed in Table E1, Appendix E; *or*
- (d) a combination of any of Items (a), (b) or (c) above.

5.7.4 Balustrades, handrails or other barriers

This Standard does not provide construction requirements for balustrades, handrails and other barriers.

5.8 WATER AND GAS SUPPLY PIPES

Above-ground, exposed water and gas supply pipes shall be metal.

SECTION 6 CONSTRUCTION FOR BUSHFIRE ATTACK LEVEL 19 (BAL—19)

6.1 GENERAL

A building assessed in Section 2 as being BAL—19 shall comply with Section 3 and Clauses 6.2 to 6.8.

NOTE: There are a number of Standards that specify requirements for construction; however, where this Standard does not provide construction requirements for a particular element, the other Standards apply.

Any element of construction or system that satisfies the test criteria of AS 1530.8.1 may be used in lieu of the applicable requirements contained in Clauses 6.2 to 6.8 (see Clause 3.8).

NOTE: BAL—19 is primarily concerned with protection from ember attack and radiant heat greater than 12.5 kW/m² up to and including 19 kW/m².

6.2 SUBFLOOR SUPPORTS

This Standard does not provide construction requirements for subfloor support posts, columns, stumps, piers and poles.

NOTE: The exclusion of requirements for subfloor supports applies to the principal building only and not to verandas, decks, steps, ramps and landings (see Clause 6.7).

C6.2 Ideally, storage of combustible materials beneath a floor at this BAL would not occur and on this assumption, there is no requirement to enclose the subfloor space or to protect flooring materials from bushfire attack. However, should combustible materials be stored, it is recommended the area be protected as materials stored in the subfloor space may be ignited by embers and cause an impact to the building.

6.3 FLOORS

6.3.1 Concrete slabs on the ground

This Standard does not provide construction requirements for concrete slabs on ground.

6.3.2 Elevated floors

This Standard does not provide construction requirements for elevated floors, including bearers, joists and flooring.

6.4 EXTERNAL WALLS

6.4.1 Walls

That part of an external wall surface that is less than 400 mm from the ground or less than 400 mm above decks, carport roofs, awnings and similar elements or fittings having an angle less than 18 degrees to the horizontal and extending more than 110 mm in width from the wall (see Figure D3, Appendix D) shall be made from—

- (a) non-combustible material; *or*
- (b) fibre-cement external cladding, a minimum of 6 mm in thickness; *or*
- (c) bushfire-resisting timber (see Appendix F); *or*
- (d) a timber species, as specified in Paragraph E1 and listed in Table E1, Appendix E; *or*
- (e) a combination of any of Items (a), (b), (c) or (d) above.

This Standard does not provide construction requirements for external wall surfaces 400 mm or more from the ground or for external wall surfaces 400 mm or more above decks, carport roofs, awnings and similar elements or fittings having an angle less than 18 degrees to the horizontal and extending more than 110 mm in width from the wall (see Figure D3, Appendix D).

6.4.2 Joints

All joints in the external surface material of walls shall be covered, sealed, overlapped, backed or butt-jointed to prevent gaps greater than 3 mm.

Alternatively, sarking-type material may be applied over the outer face of the frame prior to fixing any external cladding.

6.4.3 Vents and weepholes

Vents and weepholes in external walls shall be screened with mesh with a maximum aperture of 2 mm, made of corrosion-resistant steel, bronze or aluminium, except where they are less than 3 mm (see Clause 3.6), or are located in an external wall of a subfloor space.

6.5 EXTERNAL GLAZED ELEMENTS AND ASSEMBLIES AND EXTERNAL DOORS

6.5.1 Bushfire shutters

Where fitted, bushfire shutters shall comply with Clause 3.7 and be made from—

- (a) non-combustible material; *or*
- (b) a timber species, as specified in Paragraph E1 and listed in Table E1, Appendix E; *or*
- (c) bushfire-resisting timber (see Appendix F); *or*
- (d) a combination of any of Items (a), (b), or (c) above.

6.5.2 Windows

Window assemblies shall comply with one of the following:

- (a) They shall be completely protected by a bushfire shutter that complies with Clause 6.5.1.
or
- (b) They shall be completely protected externally by screens with a mesh with a maximum aperture of 2 mm, made of corrosion-resistant steel, bronze or aluminium.
or
- (c) They shall comply with the following:
 - (i) For window assemblies less than 400 mm from the ground or less than 400 mm above decks, carport roofs, awnings and similar elements or fittings, having an angle less than 18 degrees to the horizontal and extending more than 110 mm in width from the window frame (see Figure D3, Appendix D), window frames and window joinery, shall be made from one of the following:
 - (A) Bushfire-resisting timber (see Appendix F).
or
 - (B) A timber species, as specified in Paragraph E2 and listed in Table E2, Appendix E.
or
 - (C) Metal.
or

- (D) Metal-reinforced PVC-U. The reinforcing members shall be made from aluminium, stainless steel, or corrosion-resistant steel and the frame and the sash shall satisfy the design load, performance and structural strength of the member.
- (ii) Externally fitted hardware that supports the sash in its functions of opening and closing, shall be metal.
- (iii) Where glazing is less than 400 mm from the ground or less than 400 mm above decks, carport roofs, awnings and similar elements or fittings, having an angle less than 18 degrees to the horizontal and extending more than 110 mm in width from the window frame (see Figure D3, Appendix D), the glazing shall be toughened glass, minimum 5 mm, or glass blocks with no restriction on glazing methods.
- NOTE: Where double-glazed units are used, the above requirements apply to the external face of the window assembly only.
- (iv) Where glazing is other than that specified in Item (iii) above, annealed glass may be used. Where annealed glass is used, the fixed and openable portions of windows shall be screened externally with a mesh with a maximum aperture of 2 mm, made of corrosion-resistant steel, bronze or aluminium.
- (v) Where toughened glass is used, the openable portions of windows shall be screened internally or externally with a mesh with a maximum aperture of 2 mm, made of corrosion-resistant steel, bronze or aluminium.
- (vi) Glazed elements that are designed to take internal screens shall use toughened glass and the openable portion shall be screened in such a way to have no gaps greater than 3 mm in diameter. Screening material shall be a mesh with a maximum aperture of 2 mm, made of corrosion-resistant steel, bronze or aluminium.

6.5.3 Doors—Side-hung external doors (including French doors, panel fold and bi-fold doors)

Side-hung external doors, including French doors, panel fold and bi-fold doors, shall comply with one of the following:

- (a) They shall be protected by a bushfire shutter that complies with Clause 6.5.1.
or
- (b) They shall be completely protected externally by screens with a mesh with a maximum aperture of 2 mm, made of corrosion-resistant steel, bronze or aluminium.
or
- (c) They shall comply with the following:
- (i) Doors shall be—
- (A) non-combustible; *or*
- (B) a solid timber door, having a minimum thickness of 35 mm for the first 400 mm above the threshold; *or*
- (C) a door, including a hollow core door, with a non-combustible kickplate on the outside for the first 400 mm above the threshold; *or*
- (D) a fully-framed glazed door, where the framing is made from materials specified for bushfire shutters (see Clause 6.5.1).
- (ii) Where doors incorporate glazing, the glazing shall be toughened glass minimum 5 mm.

- (iii) Doors shall be tight-fitting to the doorframe and to an abutting door, if applicable.
- (iv) Where the doorframe is less than 400 mm from the ground or less than 400 mm above decks, carport roofs, awnings and similar elements or fittings having an angle less than 18 degrees to the horizontal and extending more than 110 mm in width from the door (see Figure D3, Appendix D) the doorframe shall be made from one of the following:
 - (A) Bushfire-resisting timber (see Appendix F).
or
 - (B) A timber species, as specified in Paragraph E2 and listed in Table E2, Appendix E.
or
 - (C) Metal.
or
 - (D) Metal-reinforced PVC-U. The reinforcing members shall be made from aluminium, stainless steel, or corrosion-resistant steel and the door assembly shall satisfy the design load, performance and structural strength of the member.
- (v) Weather strips, draught excluders or draught seals shall be installed at the base of side-hung external doors.

6.5.4 Doors—Sliding doors

Sliding doors shall comply with one of the following:

- (a) They shall be completely protected by a bushfire shutter that complies with Clause 6.5.1.
or
- (b) They shall be completely protected externally by screens with a mesh with a maximum aperture of 2 mm, made of corrosion-resistant steel, bronze or aluminium.
or
- (c) They shall comply with the following:
 - (i) Any glazing incorporated in sliding doors shall be toughened glass, minimum 5 mm.
 - (ii) There is no requirement to screen the openable part of the sliding door. However, if screened, the screens shall be mesh or perforated sheet made of corrosion-resistant steel, bronze or aluminium.
NOTE: The construction of manufactured sliding doors should prevent the entry of embers when the door is closed. There is no requirement to provide screens to the openable part of these doors as it is assumed that a sliding door will be closed if occupants are not present or during a bushfire event. Screens of materials other than those specified may not resist ember attack.
 - (iii) Sliding doors shall be tight-fitting in the frames.

6.5.5 Doors—Vehicle access doors (garage doors)

The following apply to vehicle access doors:

- (a) The lower portion of a vehicle access door that is within 400 mm of the ground when the door is closed (see Figure D4, Appendix D) shall be made from—

- (i) non-combustible material; *or*
 - (ii) bushfire-resisting timber (see Appendix F); *or*
 - (iii) fibre-cement sheet, a minimum of 6 mm in thickness; *or*
 - (iv) a timber species, as specified in Paragraph E1 and listed in Table E1, Appendix E; *or*
 - (v) a combination of any of Items (i), (ii), (iii) or (iv) above.
- (b) Panel lift, tilt doors or side-hung doors shall be fitted with suitable weather strips, draught excluders, draught seals or guide tracks, as appropriate to the door type, with a maximum gap no greater than 3 mm.
- (c) Roller doors shall have guide tracks with a maximum gap no greater than 3 mm and shall be fitted with a nylon brush that is in contact with the door (see Figure D4, Appendix D).
- (d) Vehicle access doors shall not include ventilation slots.

6.6 ROOFS (INCLUDING VERANDA AND ATTACHED CARPORT ROOFS, PENETRATIONS, EAVES, FASCIAS, GABLES, GUTTERS AND DOWNPIPES)

6.6.1 General

The following apply to all types of roofs and roofing systems:

- (a) Roof tiles, roof sheets and roof-covering accessories shall be non-combustible.
- (b) The roof/wall junction shall be sealed, to prevent openings greater than 3 mm, either by the use of fascia and eaves linings or by sealing between the top of the wall and the underside of the roof and between the rafters at the line of the wall.
- (c) Roof ventilation openings, such as gable and roof vents, shall be fitted with ember guards made of non-combustible material or a mesh or perforated sheet with a maximum aperture of 2 mm, made of corrosion-resistant steel, bronze or aluminium.

6.6.2 Tiled roofs

Tiled roofs shall be fully sarked. The sarking shall—

- (a) have a flammability index of not more than 5, when tested to AS 1530.2;
- (b) be located directly below the roof battens;
- (c) cover the entire roof area including the ridge; and
- (d) be installed so that there are no gaps that would allow the entry of embers where the sarking meets fascias, gutters, valleys and the like.

6.6.3 Sheet roofs

Sheet roofs shall—

- (a) be fully sarked in accordance with Clause 6.6.2, except that foil-backed insulation blankets may be installed over the battens;
or
- (b) have any gaps greater than 3 mm under corrugations or ribs of sheet roofing and between roof components sealed at the fascia or wall line and at valleys, hips and ridges by—
 - (i) a mesh or perforated sheet with a maximum aperture of 2 mm, made of corrosion-resistant steel, bronze or aluminium; *or*
 - (ii) mineral wool; *or*

- (iii) other non-combustible material; *or*
- (iv) a combination of any of Items (i), (ii), or (iii) above.

6.6.4 Veranda, carport and awning roofs

The following apply to veranda, carport and awning roofs:

- (a) A veranda, carport or awning roof forming part of the main roof space [see Figure D1(a), Appendix D] shall meet all the requirements for the main roof, as specified in Clauses 6.6.1, 6.6.2, 6.6.3, 6.6.5 and 6.6.6.
- (b) A veranda, carport or awning roof separated from the main roof space by an external wall [see Figures D1(b) and D1(c), Appendix D] complying with Clause 6.4 shall have a non-combustible roof covering.

NOTE: There is no requirement to line the underside of a veranda, carport or awning roof that is separate from the main roof space.

6.6.5 Roof penetrations

The following apply to roof penetrations:

- (a) Roof penetrations, including roof lights, roof ventilators, roof-mounted evaporative cooling units, aerials, vent pipes and supports for solar collectors shall be adequately sealed at the roof to prevent gaps greater than 3 mm. The material used to seal the penetration shall be non-combustible.
- (b) Openings in vented roof lights, roof ventilators or vent pipes shall be fitted with ember guards made from a mesh or perforated sheet with a maximum aperture of 2 mm, made of corrosion-resistant steel, bronze or aluminium.
- (c) All overhead glazing shall be Grade A laminated safety glass complying with AS 1288.
- (d) Glazed elements in roof lights and skylights may be of polymer provided a Grade A safety glass diffuser, complying with AS 1288, is installed under the glazing. Where glazing is an insulating glazing unit (IGU), Grade A toughened safety glass of minimum 4 mm shall be used in the outer pane of the IGU.
- (e) Flashing elements of tubular skylights may be of a fire-retardant material, provided the roof integrity is maintained by an under-flashing of a material having a flammability index no greater than 5.
- (f) Evaporative cooling units shall be fitted with butterfly closers at or near the ceiling level, or the unit shall be fitted with non-combustible covers with a mesh or perforated sheet with a maximum aperture of 2 mm, made of corrosion-resistant steel, bronze or aluminium.

6.6.6 Eaves linings, fascias and gables

The following apply to eaves linings, fascias and gables:

- (a) Gables shall comply with Clause 6.4.
- (b) Eaves penetrations shall be protected the same as for roof penetrations, as specified in Clause 6.6.5.
- (c) Eaves ventilation openings greater than 3 mm shall be fitted with ember guards made of non-combustible material or a mesh or perforated sheet with a maximum aperture of 2 mm, made of corrosion-resistant steel, bronze or aluminium.

Joints in eaves linings, fascias and gables may be sealed with plastic joining strips or timber storm moulds.

This Standard does not provide construction requirements for fascias, bargeboards and eaves linings.

6.6.7 Gutters and downpipes

This Standard does not provide material requirements for—

- (a) gutters, with the exception of box gutters; and
- (b) downpipes.

If installed, gutter and valley leaf guards shall be non-combustible.

Box gutters shall be non-combustible and flashed at the junction with the roof with non-combustible material.

6.7 VERANDAS, DECKS, STEPS, RAMPS AND LANDINGS

6.7.1 General

Decking shall be either spaced or continuous (i.e., without spacings).

There is no requirement to enclose the subfloor spaces of verandas, decks, steps, ramps or landings.

C6.7.1 Spaced decking is nominally spaced at 3 mm (in accordance with standard industry practice); however, due to the nature of timber decking with seasonal changes in moisture content, that spacing may range from 0–5 mm during service. The preferred dimension for gaps is 3 mm (which is in line with other 'permissible gaps') in other parts of this Standard. It should be noted that recent research studies have shown that gaps at 5 mm spacing afford opportunity for embers to become lodged in between timbers, which may contribute to a fire. Larger gap spacings of 10 mm may preclude this from happening but such a spacing regime may not be practical for a timber deck.

6.7.2 Enclosed subfloor spaces of verandas, decks, steps, ramps and landings

6.7.2.1 Materials to enclose a subfloor space

This Standard does not provide construction requirements for the materials used to enclose a subfloor space except where those materials are less than 400 mm from the ground.

Where the materials used to enclose a subfloor space are less than 400 mm from the ground, they shall comply with Clause 6.4.

6.7.2.2 Subfloor supports

This Standard does not provide construction requirements for subfloor support posts, columns, stumps, stringers, piers and poles.

6.7.2.3 Framing

This Standard does not provide construction requirements for the framing of verandas, decks, ramps or landings (i.e., bearers and joists).

6.7.2.4 Decking

This Standard does not provide construction requirements for decking that is more than 300 mm from a glazed element.

Decking less than 300 mm (measured horizontally at deck level) from glazed elements that are less than 400 mm (measured vertically) from the surface of the deck (see Figure D2, Appendix D) shall be made from—

- (a) non-combustible material; *or*
- (b) bushfire-resisting timber (see Appendix F); *or*
- (c) a timber species, as specified in Paragraph E1 and listed in Table E1, Appendix E; *or*

(d) a combination of any of Items (a), (b), or (c) above.

6.7.3 Unenclosed subfloor spaces of verandas, decks, steps, ramps and landings

6.7.3.1 Supports

This Standard does not provide construction requirements for support posts, columns, stumps, stringers, piers and poles.

6.7.3.2 Framing

This Standard does not provide construction requirements for the framing of verandas, decks, ramps or landings (i.e., bearers and joists).

6.7.3.3 Decking

This Standard does not provide construction requirements for decking that is more than 300 mm from a glazed element.

Decking less than 300 mm (measured horizontally at deck level) from glazed elements that are less than 400 mm (measured vertically) from the surface of the deck (see Figure D2, Appendix D) shall be made from—

- (a) non-combustible material; *or*
- (b) bushfire-resisting timber (see Appendix F); *or*
- (c) a timber species, as specified in Paragraph E1 and listed in Table E1, Appendix E; *or*
- (d) a combination of any of Items (a), (b), or (c) above.

6.7.4 Balustrades, handrails or other barriers

This Standard does not provide construction requirements for balustrades, handrails and other barriers.

6.8 WATER AND GAS SUPPLY PIPES

Above-ground, exposed water and gas supply pipes shall be metal.

SECTION 7 CONSTRUCTION FOR BUSHFIRE ATTACK LEVEL 29 (BAL—29)

7.1 GENERAL

A building assessed in Section 2 as being BAL—29 shall comply with Section 3 and Clauses 7.2 to 7.8.

NOTE: There are a number of Standards that specify requirements for construction; however, where this Standard does not provide construction requirements for a particular element, the other Standards apply.

Any element of construction or system that satisfies the test criteria of AS 1530.8.1 may be used in lieu of the applicable requirements contained in Clauses 7.2 to 7.8 (see Clause 3.8).

NOTE: BAL—29 is primarily concerned with protection from ember attack and radiant heat greater than 19 kW/m^2 up to and including 29 kW/m^2 .

7.2 SUBFLOOR SUPPORTS

This Standard does not provide construction requirements for subfloor supports where the subfloor space is enclosed with—

- (a) a wall that complies with Clause 7.4; *or*
- (b) a mesh or perforated sheet with a maximum aperture of 2 mm, made of corrosion-resistant steel, bronze or aluminium; *or*
- (c) a combination of Items (a) and (b) above.

Where the subfloor space is unenclosed, the support posts, columns, stumps, piers and poles shall be—

- (i) of non-combustible material; *or*
- (ii) of bushfire-resisting timber (see Appendix F); *or*
- (iii) a combination of Items (i) and (ii) above.

NOTE: This requirement applies to the principal building only and not to verandas, decks, steps, ramps and landings (see Clause 7.7).

C7.2 Combustible materials stored in the subfloor space may be ignited by embers and cause an impact to the building.

7.3 FLOORS

7.3.1 Concrete slabs on ground

This Standard does not provide construction requirements for concrete slabs on ground.

7.3.2 Elevated floors

7.3.2.1 Enclosed subfloor space

This Standard does not provide construction requirements for elevated floors, including bearers, joists and flooring, where the subfloor space is enclosed with—

- (a) a wall that complies with Clause 7.4; *or*
- (b) a mesh or perforated sheet with a maximum aperture of 2 mm, made of corrosion-resistant steel, bronze or aluminium; *or*
- (c) a combination of Items (a) and (b) above.

7.3.2.2 Unenclosed subfloor space

Where the subfloor space is unenclosed, flooring material, including bearers, joists and flooring less than 400 mm above finished ground level, shall be—

- (a) non-combustible (e.g., concrete, steel); *or*
- (b) of bushfire-resisting timber (see Appendix F); *or*
- (c) particleboard or plywood flooring where the underside is lined with sarking-type material or mineral wool insulation; *or*
- (d) a system complying with AS 1530.8.1; *or*
- (e) a combination of any of Items (a), (b), (c) or (d) above.

This Standard does not provide construction requirements for elements of elevated floors, including bearers, joists and flooring, if the underside of the element is 400 mm or more above finished ground level.

7.4 EXTERNAL WALLS

7.4.1 Walls

Walls shall be one of the following:

- (a) Made of non-combustible material (e.g., full masonry, brick veneer, mud brick, concrete, aerated concrete).
or
- (b) Made of timber-framed or steel-framed walls that are sarked on the outside of the frame and clad with—
 - (i) fibre-cement external cladding, a minimum of 6 mm in thickness; *or*
 - (ii) steel sheet; *or*
 - (iii) bushfire-resisting timber (see Appendix F); *or*
 - (iv) a combination of any of Items (i), (ii) or (iii) above.*or*
- (c) A combination of Items (a) and (b) above.

7.4.2 Joints

All joints in the external surface material of walls shall be covered, sealed, overlapped, backed or butt-jointed to prevent gaps greater than 3 mm.

Alternatively, sarking-type material can be applied over the frame prior to fixing any external cladding.

7.4.3 Vents and weepholes

Vents and weepholes in external walls shall be screened with a mesh with a maximum aperture of 2 mm, made of corrosion-resistant steel, bronze or aluminium, except where they are less than 3 mm (see Clause 3.6).

7.5 EXTERNAL GLAZED ELEMENTS AND ASSEMBLIES AND EXTERNAL DOORS

7.5.1 Bushfire shutters

Where fitted, bushfire shutters shall comply with Clause 3.7 and be made from—

- (a) non-combustible material; *or*



- (b) bushfire-resisting timber (see Appendix F); *or*
- (c) a combination of Items (a) and (b) above.

7.5.2 Windows

Windows shall comply with one of the following:

- (a) They shall be completely protected by a bushfire shutter that complies with Clause 7.5.1.

or

- (b) They shall comply with the following:

- (i) Window frames and window joinery and shall be made from one of the following:

- (A) Bushfire-resisting timber (see Appendix F).

or

- (B) Metal.

or

- (C) Metal-reinforced PVC-U. The reinforcing members shall be made from aluminium, stainless steel, or corrosion-resistant steel, and the frame and the sash shall satisfy the design load, performance and structural strength of the member.

- (ii) Externally fitted hardware that supports the sash in its functions of opening and closing shall be metal.

- (iii) Glazing shall be toughened glass minimum 5 mm.

- (iv) Where glazing is less than 400 mm from the ground or less than 400 mm above decks, carport roofs, awnings and similar elements or fittings having an angle less than 18 degrees to the horizontal and extending more than 110 mm in width from the window frame (see Figure D3, Appendix D) that portion shall be screened with a mesh or perforated sheet with a maximum aperture of 2 mm, made of corrosion-resistant steel, bronze or aluminium.

- (v) The openable portions of windows shall be screened with a mesh with a maximum aperture of 2 mm, made of corrosion-resistant steel, bronze or aluminium.

7.5.3 Doors—Side-hung external doors (including French doors, panel fold and bi-fold doors)

Side-hung external doors, including French doors, panel fold and bi-fold doors, shall comply with one of the following:

- (a) They shall be protected by a bushfire shutter that complies with Clause 7.5.1.

or

- (b) They shall be completely protected externally by screens with a mesh with a maximum aperture of 2 mm, made of corrosion-resistant steel, bronze or aluminium

or

- (c) They shall comply with the following:

- (i) Doors shall be—

- (A) non-combustible; *or*

- (B) a solid timber door, having a minimum thickness of 35 mm for the first 400 mm above the threshold; *or*
 - (C) a door, including a hollow core door, protected on the outside by a screen door or a mesh or perforated sheet with a maximum aperture of 2 mm, made of corrosion-resistant steel, bronze or aluminium; *or*
 - (D) a fully framed glazed door, where the framing is made from non-combustible materials or from bushfire-resisting timber (see Appendix F).
- (ii) Externally fitted hardware that supports the panel in its functions of opening and closing shall be metal.
 - (iii) Where doors incorporate glazing, the glazing shall be toughened glass, minimum 5 mm.
 - (iv) Where glazing is less than 400 mm from the ground or less than 400 mm above decks, carport roofs, awnings and similar elements or fittings having an angle less than 18 degrees to the horizontal and extending more than 110 mm in width from the door (see Figure D3, Appendix D), that portion shall be screened with a mesh or perforated sheet with a maximum aperture of 2 mm, made of corrosion-resistant steel, bronze or aluminium.
 - (v) Doorframes shall be made from one of the following:
 - (A) Bushfire-resisting timber (see Appendix F).
or
 - (B) Metal.
or
 - (C) Metal-reinforced PVC-U. The reinforcing members shall be made from aluminium, stainless steel, or corrosion-resistant steel and the door assembly shall satisfy the design load, performance and structural strength of the member.
 - (vi) Doors shall be tight-fitting to the doorframe and to an abutting door, if applicable.
 - (vii) Weather strips, draught excluders or draught seals shall be installed at the base of side-hung external doors.

7.5.4 Doors—Sliding doors

Sliding doors shall comply with one of the following:

- (a) They shall be protected by a bushfire shutter that complies with Clause 7.5.1.
or
- (b) They shall be completely protected externally by screens with a mesh with a maximum aperture of 2 mm, made of corrosion-resistant steel, bronze or aluminium.
or
- (c) They shall comply with the following:
 - (i) Doorframes shall be of bushfire-resisting timber (see Appendix F) or aluminium or steel.
 - (ii) Externally fitted hardware that supports the panel in its functions of opening and closing shall be metal.
 - (iii) Where sliding doors incorporate glazing, the glazed assembly shall be toughened glass minimum 6 mm except where both the fixed and openable portions of doors are screened by a mesh or perforated sheet with a maximum aperture of 2 mm, made of corrosion-resistant steel, bronze or aluminium.

- (iv) Sliding doors shall be tight-fitting in the frames.

7.5.5 Doors—Vehicle access doors (garage doors)

The following apply to vehicle access doors:

- (a) Vehicle access doors shall be made from—
 - (i) non-combustible material; *or*
 - (ii) bushfire-resisting timber (see Appendix F); *or*
 - (iii) fibre-cement sheet, a minimum of 6 mm in thickness; *or*
 - (iv) a combination of any of Items (i), (ii) or (iii) above.
- (b) Panel lift, tilt doors or side-hung doors shall be fitted with suitable weather strips, draught excluders, draught seals or guide tracks, as appropriate to the door type, with a maximum gap no greater than 3 mm.
- (c) Roller doors shall have guide tracks with a maximum gap no greater than 3 mm and shall be fitted with a nylon brush that is in contact with the door (see Figure D4, Appendix D).
- (d) Vehicle access doors shall not include ventilation slots.

7.6 ROOFS (INCLUDING VERANDA AND ATTACHED CARPORT ROOFS, PENETRATIONS, EAVES, FASCIAS, GABLES, GUTTERS AND DOWNPIPES)

7.6.1 General

The following apply to all types of roofs and roofing systems:

- (a) Roof tiles, roof sheets and roof-covering accessories shall be non-combustible.
- (b) The roof/wall junction shall be sealed, to prevent openings greater than 3 mm, either by the use of fascia and eaves linings or by sealing between the top of the wall and the underside of the roof and between the rafters at the line of the wall.
- (c) Roof ventilation openings, such as gable and roof vents, shall be fitted with ember guards made of non-combustible material or a mesh or perforated sheet with a maximum aperture of 2 mm, made of corrosion-resistant steel, bronze or aluminium.
- (d) A pipe or conduit that penetrates the roof covering shall be non-combustible.

7.6.2 Tiled roofs

Tiled roofs shall be fully sarked. The sarking shall—

- (a) have a flammability index of not more than 5, when tested to AS 1530.2;
- (b) be located directly below the roof battens;
- (c) cover the entire roof area including the ridge; and
- (d) extend into gutters and valleys.

7.6.3 Sheet roofs

Sheet roofs shall—

- (a) be fully sarked in accordance with Clause 7.6.2, except that foil-backed insulation blankets may be installed over the battens;

or

- (b) have any gaps greater than 3 mm under corrugations or ribs of sheet roofing and between roof components sealed at the fascia or wall line and at valleys, hips and ridges by—
- (i) a mesh or perforated sheet with a maximum aperture of 2 mm, made of corrosion-resistant steel, bronze or aluminium; *or*
 - (ii) mineral wool; *or*
 - (iii) other non-combustible material; *or*
 - (iv) a combination of any of Items (i), (ii) or (iii) above.

7.6.4 Veranda, carport and awning roofs

The following apply to veranda, carport and awning roofs:

- (a) A veranda, carport or awning roof forming part of the main roof space [see Figure D1(a), Appendix D] shall meet all the requirements for the main roof, as specified in Clauses 7.6.1, 7.6.2, 7.6.3, 7.6.5 and 7.6.6.
- (b) A veranda, carport or awning roof separated from the main roof space by an external wall [see Figures D1(b) and D1(c), Appendix D] complying with Clause 7.4 shall have a non-combustible roof covering and the support structure shall be—
 - (i) of non-combustible material; *or*
 - (ii) bushfire-resisting timber (see Appendix F); *or*
 - (iii) timber rafters lined on the underside with fibre-cement sheeting a minimum of 6 mm in thickness, or with material complying with AS 1530.8.1; *or*
 - (iv) a combination of any of Items (i), (ii) or (iii) above.

7.6.5 Roof penetrations

The following apply to roof penetrations:

- (a) Roof penetrations, including roof lights, roof ventilators, roof-mounted evaporative cooling units, arials, vent pipes and supports for solar collectors, shall be adequately sealed at the roof to prevent gaps greater than 3 mm. The material used to flash the penetration shall be non-combustible.
- (b) Openings in vented roof lights, roof ventilators or vent pipes shall be fitted with ember guards made from a mesh or perforated sheet with a maximum aperture of 2 mm, made of corrosion-resistant steel, bronze or aluminium.
- (c) All overhead glazing shall be Grade A laminated safety glass complying with AS 1288.
- (d) Glazed elements in roof lights and skylights may be of polymer provided a Grade A safety glass diffuser, complying with AS 1288, is installed under the glazing. Where glazing is an insulating glazing unit (IGU), Grade A toughened safety glass, minimum 4 mm, shall be used in the outer pane of the IGU.
- (e) Where roof lights are installed in roofs having a pitch of less than 18 degrees to the horizontal, the glazing shall be protected with ember guards made from a mesh or perforated sheet with a maximum aperture of 2 mm, made of corrosion-resistant steel, bronze or aluminium.
- (f) Evaporative cooling units shall be fitted with butterfly closers at or near the ceiling level, or the unit shall be fitted with non-combustible covers with a mesh or perforated sheet with a maximum aperture of 2 mm, made of corrosion-resistant steel, bronze or aluminium.

7.6.6 Eaves linings, fascias and gables

The following apply to eaves linings, fascias and gables:

- (a) Joints in eaves linings, fascias and gables may be sealed with plastic joining strips or timber storm moulds.
- (b) Gables shall comply with Clause 7.4.
- (c) Fascias and bargeboards shall—
 - (i) where timber is used, be made from bushfire-resisting timber (see Appendix F);
or
 - (ii) where made from metal, be fixed at 450 mm centres; *or*
 - (iii) be a combination of Items (i) and (ii) above.
- (d) Eaves linings shall be—
 - (i) fibre-cement sheet, a minimum 4.5 mm in thickness; *or*
 - (ii) bushfire-resisting timber (see Appendix F); *or*
 - (iii) a combination of Items (i) and (ii) above.
- (e) Eaves penetrations shall be protected the same as for roof penetrations (see Clause 7.6.5).
- (f) Eaves ventilation openings greater than 3 mm shall be fitted with ember guards made of non-combustible material or a mesh or perforated sheet with a maximum aperture of 2 mm, made of corrosion-resistant steel, bronze or aluminium.

7.6.7 Gutters and downpipes

This Standard does not provide construction-specific material requirements for downpipes.

If installed, gutter and valley leaf guards shall be non-combustible.

With the exception of box gutters, gutters shall be metal or PVC-U.

Box gutters shall be non-combustible and flashed at the junction with the roof, with non-combustible materials.

7.7 VERANDAS, DECKS, STEPS, RAMPS AND LANDINGS

7.7.1 General

Decking shall be either spaced or continuous (i.e., without spacing).

There is no requirement to enclose the subfloor spaces of verandas, decks, steps, ramps or landings.

C7.7.1 Spaced decking is nominally spaced at 3 mm (in accordance with standard industry practice); however, due to the nature of timber decking with seasonal changes in moisture content, that spacing may range from 0–5 mm during service. The preferred dimension for gaps is 3 mm (which is in line with other 'permissible gaps') in other parts of this Standard. It should be noted that recent research studies have shown that gaps at 5 mm spacing afford opportunity for embers to become lodged in between timbers, which may contribute to a fire. Larger gap spacings of 10 mm may preclude this from happening but such a spacing regime may not be practical for a timber deck.

7.7.2 Enclosed subfloor spaces of verandas, decks, steps, ramps and landings

7.7.2.1 Materials to enclose a subfloor space

The subfloor spaces of verandas, decks, steps, ramps and landings are considered to be 'enclosed' when—

- (a) the material used to enclose the subfloor space is—
 - (i) non-combustible; *or*
 - (ii) bushfire-resisting timber (see Appendix F); *or*
 - (iii) a mesh or perforated sheet with a maximum aperture of 2 mm, made of corrosion-resistant steel, bronze or aluminium; *or*
 - (iv) a combination of any of Items (i), (ii) or (iii) above; and
- (b) all openings greater than 3 mm are screened with a mesh or perforated sheet with a maximum aperture of 2 mm, made of corrosion-resistant steel, bronze or aluminium.

7.7.2.2 Supports

This Standard does not provide construction requirements for support posts, columns, stumps, stringers, piers and poles.

7.7.2.3 Framing

This Standard does not provide construction requirements for the framing of verandas, decks, ramps or landings (i.e., bearers and joists).

7.7.2.4 Decking

Decking shall be—

- (a) of non-combustible material; *or*
- (b) of bushfire-resisting timber (see Appendix F); *or*
- (c) a combination of Items (a) and (b) above.

7.7.3 Unenclosed subfloor spaces of verandas, decks, steps, ramps and landings

7.7.3.1 Supports

Support posts, columns, stumps, stringers, piers and poles shall be—

- (a) of non-combustible material; *or*
- (b) of bushfire-resisting timber (see Appendix F); *or*
- (c) a combination of Items (a) and (b) above.

7.7.3.2 Framing

Framing of verandas, decks, ramps or landings (i.e., bearers and joists) shall be—

- (a) of non-combustible material; *or*
- (b) of bushfire-resisting timber (see Appendix F); *or*
- (c) a combination of Items (a) and (b) above.

7.7.3.3 Decking

Decking shall be—

- (a) of non-combustible material; *or*
- (b) of bushfire-resisting timber (see Appendix F); *or*
- (c) a combination of Items (a) and (b) above.

7.7.4 Balustrades, handrails or other barriers

Those parts of the handrails and balustrades less than 125 mm from any glazing or any combustible wall shall be—

- (a) of non-combustible material; *or*
- (b) bushfire-resisting timber (see Appendix F); *or*
- (c) a combination of Items (i) and (ii) above.

Those parts of the handrails and balustrades that are 125 mm or more from the building have no requirements.

7.8 WATER AND GAS SUPPLY PIPES

Above-ground, exposed water and gas supply pipes shall be metal.

SECTION 8 CONSTRUCTION FOR BUSHFIRE ATTACK LEVEL 40 (BAL—40)

8.1 GENERAL

A building assessed in Section 2 as being BAL—40 shall comply with Section 3 and Clauses 8.2 to 8.8.

NOTE: There are a number of Standards that specify requirements for construction; however, where this Standard does not provide construction requirements for a particular element, the other Standards apply.

Any element of construction or system that satisfies the test criteria of AS 1530.8.1 may be used in lieu of the applicable requirements of Clauses 8.2 to 8.8, see Clause 3.8.

NOTE: BAL—40 is primarily concerned with protection from ember attack, increased likelihood of flame contact and radiant heat greater than 29 kW/m² and up to and including 40 kW/m².

8.2 SUBFLOOR SUPPORTS

This Standard does not provide construction requirements for subfloor supports where the subfloor space is enclosed with a wall that complies with Clause 8.4.

Where the subfloor space is unenclosed, the support posts, columns, stumps, piers and poles shall be—

- (a) of non-combustible material; *or*
- (b) a system complying with AS 1530.8.1; *or*
- (c) a combination of Items (a) and (b) above.

NOTE: This requirement applies to the principal building only and not to verandas, decks, steps, ramps and landings (see Clause 8.7).

C8.2 Combustible materials stored in the subfloor space may be ignited by embers and cause an impact to the building.

8.3 FLOORS

8.3.1 Concrete slabs on ground

This Standard does not provide construction requirements for concrete slabs on ground.

8.3.2 Elevated floors

8.3.2.1 Enclosed subfloor spaces

This Standard does not provide construction requirements for elevated floors, including bearers, joists and flooring, where the subfloor space is enclosed with a wall that complies with Clause 8.4.

8.3.2.2 Unenclosed subfloor spaces

Where the subfloor space is unenclosed, the flooring material, including bearers, joists and flooring, shall—

- (a) be non-combustible (e.g., concrete, steel); *or*
- (b) have the underside of the combustible elements of the floor system protected with a non-combustible material (e.g., fibre-cement sheet or metal sheet); *or*
- (c) comply with AS 1530.8.1; *or*
- (d) be a combination of any of Items (a), (b) or (c) above.

8.4 EXTERNAL WALLS

8.4.1 Walls

Walls shall be one of the following:

- (a) Walls made from non-combustible material (e.g., full masonry, brick veneer, mud brick, concrete, aerated concrete).
or
- (b) Timber-framed or steel-framed walls that are sarked on the outside of the frame and clad with—
 - (i) fibre-cement external cladding, a minimum of 9 mm in thickness; *or*
 - (ii) steel sheeting; *or*
 - (iii) a combination of Items (i) and (ii) above.*or*
- (c) A system complying with AS 1530.8.1.
or
- (d) A combination of any of Items (a), (b) or (c) above.

8.4.2 Joints

All joints in the external surface material of walls shall be covered, sealed, overlapped, backed or butt-jointed to prevent gaps greater than 3 mm.

Alternatively, sarking-type material may be applied over the frame prior to fixing any external cladding.

8.4.3 Vents and weepholes

Vents and weepholes in external walls shall be screened with a mesh with a maximum aperture of 2 mm, made of corrosion-resistant steel or bronze except where they are less than 3 mm (see Clause 3.6).

8.5 EXTERNAL GLAZED ELEMENTS AND ASSEMBLIES AND EXTERNAL DOORS

8.5.1 Bushfire shutters

Where fitted, bushfire shutters shall comply with Clause 3.7 and be made from non-combustible material.

8.5.2 Windows

Window assemblies shall comply with one of the following:

- (a) They shall be completely protected by a bushfire shutter that complies with Clause 8.5.1.
or
- (b) They shall comply with the following:
 - (i) Window frames and hardware shall be metal.
 - (ii) Glazing shall be toughened glass, minimum 5 mm.
 - (iii) Both the openable and the fixed portions of the window shall be screened with a mesh with a maximum aperture of 2 mm, made of corrosion-resistant steel or bronze.

- (iv) Seals to stiles, head and sills or thresholds shall be manufactured from materials having a flammability index no greater than 5.

8.5.3 Doors—Side-hung external doors (including French doors, panel fold and bi-fold doors)

Side-hung external doors, including French doors, panel fold and bi-fold doors, shall comply with one of the following:

- (a) They shall be protected by a bushfire shutter that complies with Clause 8.5.1.
or
- (b) They shall comply with the following:
 - (i) Doors shall be—
 - (A) non-combustible; *or*
 - (B) a solid timber door, having a minimum thickness of 35 mm for the first 400 mm above the threshold and protected on the outside by a metal-framed screen door with a mesh or perforated sheet with a maximum aperture of 2 mm, made of corrosion-resistant steel or bronze; *or*
 - (C) a fully framed glazed door where the framing is made from non-combustible material.
 - (ii) Externally fitted hardware that supports the panel in its functions of opening and closing shall be made of materials that have an FRL of at least -/30/-.
 - (iii) Where doors incorporate glazing, the glazing shall be toughened glass minimum 6 mm.
 - (iv) Where glazing is less than 400 mm from the ground or less than 400 mm above decks, carport roofs, awnings and similar elements or fittings having an angle less than 18 degrees to the horizontal and extending more than 110 mm in width from the door (see Figure D3, Appendix D) that portion of the glazing shall be screened with a mesh or perforated sheet with a maximum aperture of 2 mm, made of corrosion-resistant steel or bronze.
 - (v) Seals to stiles, head and sills or thresholds shall be manufactured from silicone.
 - (vi) Doorframes shall be metal.
 - (vii) Doors shall be tight-fitting to the doorframe and to an abutting door, if applicable.
 - (viii) Weather strips, draught excluders or draught seals shall be installed at the base of side-hung external doors.

8.5.4 Doors—Sliding doors

Sliding doors shall comply with one of the following:

- (a) They shall be protected by a bushfire shutter that complies with Clause 8.5.1.
or
- (b) They shall comply with the following:
 - (i) Doorframes shall be of metal.
 - (ii) Externally fitted hardware that supports the panel in its functions of opening and closing shall be metal.

- (iii) Where sliding doors incorporate glazing, the glazing shall have an FRL of at least $-/30/-$ except where both the fixed and openable portions of doors are screened by a mesh or perforated sheet with a maximum aperture of 2 mm, made of corrosion-resistant steel or bronze.
- (iv) Seals to stiles, head and sills or thresholds shall be manufactured from silicone.
- (v) Sliding doors shall be tight-fitting in the frames.

8.5.5 Doors—Vehicle access doors (garage doors)

The following apply to vehicle access doors:

- (a) Vehicle access doors shall be non-combustible.
- (b) Panel lift, tilt doors or side-hung doors shall be fitted with suitable weather strips, draught excluders, draught seals or guide tracks, as appropriate to the door type, with a maximum gap no greater than 3 mm.
- (c) Roller doors shall have guide tracks with a maximum gap no greater than 3 mm and shall be fitted with a nylon brush that is in contact with the door (see Figure D4, Appendix D).
- (d) Vehicle access doors shall not include ventilation slots.

8.6 ROOFS (INCLUDING VERANDA AND ATTACHED CARPORT ROOFS, PENETRATIONS, EAVES, FASCIAS, GABLES, GUTTERS AND DOWNPIPES)

8.6.1 General

The following provisions apply to all types of roofs and roofing systems:

- (a) Roof tiles, roof sheets and roof-covering accessories shall be non-combustible.
- (b) The roof/wall junction shall be sealed, to prevent openings greater than 3 mm, either by the use of fascia and eaves linings or by sealing between the top of the wall and the underside of the roof and between the rafters at the line of the wall.
- (c) Roof ventilation openings, such as gable and roof vents, shall be fitted with ember guards made of non-combustible material or a mesh or perforated sheet with a maximum aperture of 2 mm, made of corrosion-resistant steel or bronze.
- (d) A pipe or conduit that penetrates the roof covering shall be non-combustible.

Roof-mounted evaporative coolers are excluded from this level (i.e., BAL—40).

8.6.2 Tiled roofs

Tiled roofs shall be fully sarked. The sarking shall—

- (a) have a flammability index of not more than 5, when tested to AS 1530.2;
- (b) be located directly below the roof battens;
- (c) cover the entire roof area including the ridge; and
- (d) extend into gutters and valleys.

8.6.3 Sheet roofs

Sheet roofs shall—

- (a) be fully sarked in accordance with Clause 8.6.2, except that foil-backed insulation blankets may be installed over the battens;

or

- (b) have any gaps greater than 3 mm under corrugations or ribs of sheet roofing and between roof components sealed at the fascia or wall line and at valleys, hips and ridges by—
 - (i) a mesh or perforated sheet with a maximum aperture of 2 mm, made of corrosion-resistant steel or bronze; *or*
 - (ii) mineral wool; *or*
 - (iii) other non-combustible material; *or*
 - (iv) a combination of any of Items (i), (ii) or (iii) above.

8.6.4 Veranda, carport and awning roofs

The following apply to veranda, carport and awning roofs:

- (a) A veranda, carport or awning roof forming part of the main roof space [see Figure D1(a), Appendix D] shall meet all the requirements for the main roof, as specified in Clauses 8.6.1, 8.6.2, 8.6.3, 8.6.5 and 8.6.6.
- (b) A veranda, carport or awning roof separated from the main roof space by an external wall [see Figures D1(b) and D1(c), Appendix D] complying with Clause 8.4 shall have a non-combustible roof covering and the support structure shall be—
 - (i) of non-combustible material; *or*
 - (ii) timber rafters lined on the underside with fibre-cement sheeting a minimum of 6 mm in thickness, or with material complying with AS 1530.8.1; *or*
 - (iii) a system complying with AS 1530.8.1; *or*
 - (iv) a combination of any of Items (i), (ii) or (iii) above.

8.6.5 Roof penetrations

The following apply to roof penetrations:

- (a) Roof penetrations, including roof lights, roof ventilators, aerials, vent pipes and supports for solar collectors, shall be adequately sealed at the roof to prevent gaps greater than 3 mm. The material used to flash the penetration shall be non-combustible.
- (b) Glazed assemblies for roof lights and skylights shall have an FRL of -/30/-.
- (c) Where roof lights are installed in roofs having a pitch of less than 18 degrees to the horizontal, the glazing shall be protected with ember guards made from a mesh or perforated sheet with a maximum aperture of 2 mm, made of corrosion-resistant steel or bronze.

8.6.6 Eaves linings, fascias and gables

The following apply to eaves linings, fascias and gables:

- (a) Joints in eaves linings, fascias and gables may be sealed with plastic joining strips or timber storm moulds.
- (b) Gables shall comply with Clause 8.4.
- (c) Fascias and bargeboards shall comply with AS 1530.8.1.
- (d) Eaves linings shall be—
 - (i) fibre-cement sheet, a minimum of 6 mm in thickness; *or*
 - (ii) calcium silicate sheet, a minimum of 6 mm in thickness; *or*
 - (iii) a combination of Items (i) and (ii) above.

- (e) Eaves penetrations shall be protected the same as for roof penetrations as specified in Clause 8.6.5.
- (f) Eaves ventilation openings greater than 3 mm shall be fitted with ember guards made of non-combustible material, or a mesh, or perforated sheet with a maximum aperture of 2 mm, made of corrosion-resistant steel or bronze.

8.6.7 Gutters and downpipes

This Standard does not provide construction-specific material requirements for downpipes.

If installed, gutter and valley leaf guards shall be non-combustible.

Gutters shall be non-combustible.

Box gutters shall be non-combustible and flashed at the junction with the roof with non-combustible materials.

8.7 VERANDAS, DECKS, STEPS, RAMPS AND LANDINGS

8.7.1 General

Decking shall be either spaced or continuous (i.e., without spacing).

There is no requirement to enclose the subfloor spaces of verandas, decks, steps, ramps or landings.

C8.7.1 Spaced decking is nominally spaced at 3 mm (in accordance with standard industry practice); however, due to the nature of timber decking with seasonal changes in moisture content, that spacing may range from 0–5 mm during service. The preferred dimension for gaps is 3 mm (which is in line with other 'permissible gaps') in other parts of this Standard. It should be noted that recent research studies have shown that gaps at 5 mm spacing afford opportunity for embers to become lodged in between timbers, which may contribute to a fire. Larger gap spacings of 10 mm may preclude this from happening but such a spacing regime may not be practical for a timber deck.

8.7.2 Enclosed subfloor spaces of verandas, decks, steps, ramps and landings

8.7.2.1 Materials to enclose a subfloor space

The subfloor spaces of verandas, decks, steps, ramps and landings are deemed to be 'enclosed' when—

- (a) the material used to enclose the subfloor space complies with Clause 8.4; and
- (b) all openings greater than 3 mm are screened with a mesh or perforated sheet with a maximum aperture of 2 mm, made of corrosion-resistant steel or bronze.

8.7.2.2 Supports

This Standard does not provide construction requirements for support posts, columns, stumps, stringers, piers and poles.

8.7.2.3 Framing

This Standard does not provide construction requirements for the framing of verandas, decks, ramps or landings (i.e., bearers and joists).

8.7.2.4 Decking

Decking shall be—

- (a) of non-combustible material; or
- (b) a system complying with AS 1530.8.1, or
- (c) a combination of Items (a) and (b) above.



8.7.3 Unenclosed subfloor spaces of verandas, decks, steps, ramps and landings

8.7.3.1 Supports

Support posts, columns, stumps, stringers, piers and poles shall be—

- (a) of non-combustible material; *or*
- (b) a system complying with AS 1530.8.1; *or*
- (c) a combination of Items (a) and (b) above.

8.7.3.2 Framing

Framing of verandas, decks, ramps or landings (i.e., bearers and joists) shall be—

- (a) of non-combustible material; *or*
- (b) a system complying with AS 1530.8.1; *or*
- (c) a combination of Items (a) and (b) above.

8.7.3.3 Decking

Decking shall be—

- (a) of non-combustible material; *or*
- (b) a system complying with AS 1530.8.1; *or*
- (c) a combination of Items (a) and (b) above.

8.7.4 Balustrades, handrails or other barriers

Those parts of the handrails and balustrades less than 125 mm from any glazing or any combustible wall shall be of non-combustible material.

Those parts of the handrails and balustrades that are 125 mm or more from the building have no requirements.

8.8 WATER AND GAS SUPPLY PIPES

Above-ground, exposed water and gas supply pipes shall be metal.

SECTION 9 CONSTRUCTION FOR BUSHFIRE ATTACK LEVEL FZ (BAL—FZ)

9.1 GENERAL

A building assessed in Section 2 as being BAL—FZ shall comply with Section 3 and Clauses 9.2 to 9.8 and have a minimum setback distance of 10 m from the classified vegetation.

In circumstances where the 10 m setback distance cannot be achieved, those elements of the building that are less than 10 m from the classified vegetation shall comply with AS 1530.8.2.

NOTE: There are a number of Standards that specify requirements for construction; however, where this Standard does not provide construction requirements for a particular element, the other Standards apply.

Any element of construction or system that satisfies the test criteria of AS 1530.8.2 may be used in lieu of the applicable requirements contained in Clauses 9.2 to 9.8, see Clause 3.8.

NOTES:

- 1 BAL—FZ is primarily concerned with protection from flame contact together with ember attack and radiant heat of more than 40 kW/m².
- 2 Construction in the Flame Zone BAL—FZ may require reliance on measures other than construction. The requirements for construction of a building in the Flame Zone is regulated by the building authorities having jurisdiction in the States and Territories of Australia.

9.2 SUBFLOOR SUPPORTS

This Standard does not provide construction requirements for subfloor supports where the subfloor space is enclosed with a wall that complies with Clause 9.4.

Where the subfloor space is unenclosed, systems, including support posts, columns, stumps, piers and poles, shall—

- (a) have an FRL of at least 30/—/— and shall be non-combustible; *or*
- (b) be a system complying with AS 1530.8.2; *or*
- (c) be a combination of Items (a) and (b) above.

NOTE: This requirement applies to the principal building only and not to verandas, decks, steps, ramps and landings (see Clause 9.7).

C9.2 Combustible materials stored in the subfloor space may be ignited by embers and cause an impact to the building.

9.3 FLOORS

9.3.1 Concrete slabs on ground

This Standard does not provide construction requirements for concrete slabs on ground.

9.3.2 Elevated floors

9.3.2.1 Enclosed subfloor spaces

This Standard does not provide construction requirements for elevated floors, including bearers, joists and flooring, where the subfloor space is enclosed with a wall that complies with Clause 9.4.



9.3.2.2 *Unenclosed subfloor spaces*

Where the subfloor space is unenclosed, the floor system, including bearers, joist and flooring, shall—

- (a) have an FRL of at least 30/30/30 and the surface material shall be non-combustible (e.g., concrete, steel); *or*
- (b) have the underside of the combustible elements of the floor system protected with a 30 min resistance to incipient spread of fire system; *or*
- (c) comply with AS 1530.8.2 when tested from the underside; *or*
- (d) be a combination of any of Items (a), (b) or (c) above.

9.4 EXTERNAL WALLS

9.4.1 Walls

Walls shall be one of the following:

- (a) Walls made of non-combustible material (e.g., masonry, brick veneer, mud brick, aerated concrete, concrete) with a minimum of 90 mm in thickness.
or
- (b) A system complying with AS 1530.8.2 when tested from the outside.
or
- (c) A system with an FRL of 30/30/30 or $-/30/30$ when tested from the outside.
or
- (d) A combination of any of Items (a), (b) or (c) above.

9.4.2 Joints

All joints in the external surface material of walls shall be covered, sealed, overlapped, backed or butt-jointed to prevent gaps greater than 3 mm.

Alternatively, sarking-type material may be applied over the frame prior to fixing any external cladding.

9.4.3 Vents and weepholes

Vents and weepholes in external walls shall be screened with a mesh with a maximum aperture of 2 mm, made of corrosion-resistant steel or bronze, except where they are less than 3 mm (see Clause 3.6).

9.5 EXTERNAL GLAZED ELEMENTS AND ASSEMBLIES AND EXTERNAL DOORS

9.5.1 Bushfire shutters

Where fitted, bushfire shutters shall comply with—

- (a) Clause 3.7, except that perforations are not acceptable over the door system; and
- (b) AS 1530.8.2 when tested from the outside.

9.5.2 Windows

Window assemblies shall comply with one of the following:

- (a) They shall be completely protected by a bushfire shutter that complies with Clause 9.5.1.
or

- (b) The openable portion of the window shall be screened with a mesh with a maximum aperture of 2 mm, made of corrosion-resistant steel or bronze; and either—
 - (i) the window system shall have an FRL of at least $-/30/-$; *or*
 - (ii) the window system shall comply with AS 1530.8.2 when tested from the outside.

9.5.3 Doors—Side-hung external doors (including French doors, panel fold and bi-fold doors)

Side-hung external doors, including French doors, panel fold and bi-fold doors, shall comply with one of the following:

- (a) They shall be protected by a bushfire shutter that complies with Clause 9.5.1.
or
- (b) They shall comply with the following:
 - (i) All door systems, including doorframes and doors with glazed panels, shall—
 - (A) have an FRL of at least $-/30/-$; *or*
 - (B) comply with AS 1530.8.2 when tested from the outside.
 - (ii) Doors shall be tight-fitting to the doorframe and to an abutting door, if applicable.
 - (iii) Weather strips, draught excluders or draught seals shall be installed at the base of side-hung external doors.
 - (iv) Seals shall not compromise the FRL or the performance achieved in AS 1530.4.

9.5.4 Doors—Sliding doors

Sliding doors shall comply with one of the following:

- (a) They shall be completely protected by a bushfire shutter that complies with Clause 9.5.1.
or
- (b) They shall comply with the following:
 - (i) All sliding door systems, including those with glazed panels, shall—
 - (A) have an FRL of at least $-/30/-$; *or*
 - (B) comply with AS 1530.8.2 when tested from the outside.
 - (ii) Sliding doors shall be tight-fitting in the frames.

9.5.5 Doors—Vehicle access doors (garage doors)

The following apply to vehicle access doors:

- (a) Vehicle access doors shall be non-combustible.
- (b) Where the garage is attached to the building, the requirements of Clause 3.2.2(b) shall apply.
- (c) Panel lift, tilt doors or side-hung doors shall be fitted with suitable weather strips, draught excluders, draught seals or guide tracks, as appropriate to the door type, with a maximum gap no greater than 3 mm.
- (d) Roller doors shall have guide tracks with a maximum gap no greater than 3 mm and shall be fitted with a nylon brush that is in contact with the door (see Figure D4, Appendix D).

- (e) Vehicle access doors shall not include ventilation slots.

9.6 ROOFS (INCLUDING VERANDA AND ATTACHED CARPORT ROOFS, PENETRATIONS, EAVES, FASCIAS, GABLES, GUTTERS AND DOWNPIPES)

9.6.1 General

The following apply to all types of roofs and roofing systems:

- (a) The roof or roofing system shall be one of the following:
- (i) A system complying with AS 1530.8.2 when tested from the outside.
or
 - (ii) A system with an FRL of 30/30/30 or -/30/30 when tested from the outside.
or
 - (iii) A combination of Items (i) and (ii) above.
- (b) The roof/wall junction shall be sealed, to prevent openings greater than 3 mm, either by the use of fascia and eaves linings or by sealing between the top of the wall and the underside of the roof and between the rafters at the line of the wall.
- (c) Roof ventilation openings, such as gable and roof vents, shall be fitted with ember guards made of non-combustible material or a mesh or perforated sheet with a maximum aperture of 2 mm, made of corrosion-resistant steel or bronze.
- (d) Pipe or conduit that penetrates the roof covering shall be metal, excluding aluminium.

Roof-mounted evaporative coolers are excluded from this level.

9.6.2 Veranda, carport and awning roofs

The following apply to veranda, carport and awning roofs:

- (a) A veranda, carport or awning roof forming part of the main roof space [see Figure D1(a), Appendix D] shall meet all the requirements for the main roof, as specified in Clauses 9.6.1, 9.6.3, and 9.6.4.
- (b) A veranda, carport or awning roof separated from the main roof space by an external wall [see Figures D1(b) and D1(c), Appendix D] complying with Clause 9.4 shall have a non-combustible roof covering and the support structure shall be—
- (i) of non-combustible material; *or*
 - (ii) timber rafters lined on the underside with fibre-cement sheet a minimum of 6 mm in thickness, or with material complying with AS 1530.8.2; *or*
 - (iii) a system complying with AS 1530.8.2; *or*
 - (iv) a combination of any of Items (i), (ii) or (iii) above.

9.6.3 Roof penetrations

The following apply to roof penetrations:

- (a) Roof penetrations, including roof lights, roof ventilators, aerials, vent pipes and supports for solar collectors, shall be sealed with mineral fibre at the roof to prevent gaps. Where the gap between the roof covering and the roof penetration is greater than 3 mm, the material used to seal the penetration shall be non-combustible.

NOTE: As a general principle, the service penetration should not significantly compromise the performance of the element of construction it penetrates nor should it be a means to allow the passage of burning embers or heat transfer such that fire may spread to the interior of a structure.

- (b) Roof lights and roof ventilators shall be one of the following:
- (i) A system complying with AS 1530.8.2 when tested from the outside.
- or*
- (ii) A system with an FRL of 30/30/30 or -/30/30 when tested from the outside.

9.6.4 Eaves linings, fascias and gables

The following apply to eaves linings, fascias and gables:

- (a) Joints in eaves linings, fascias and gables may be sealed with plastic joining strips or timber storm moulds.
- (b) Gables shall comply with Clause 9.4.
- (c) Fascias and bargeboards shall comply with AS 1530.8.2.
- (d) Eaves linings shall be—
 - (i) a system with an FRL of -/30/30; *or*
 - (ii) a system complying with AS 1530.8.2; *or*
 - (iii) a combination of Items (i) and (ii) above.
- (e) Eaves penetrations shall be protected the same as for roof penetrations, as specified in Clause 9.6.3.
- (f) Eaves ventilation openings greater than 3 mm shall be fitted with ember guards made of non-combustible material or a mesh or perforated sheet with a maximum aperture of 2 mm, made of corrosion-resistant steel or bronze.

9.6.5 Gutters and downpipes

This Standard does not provide construction-specific material requirements for downpipes.

If installed, gutter and valley leaf guards shall be non-combustible.

Gutters shall be non-combustible.

Box gutters shall be non-combustible and flashed at the junction with the roof with non-combustible materials.

9.7 VERANDAS, DECKS, STEPS, RAMPS AND LANDINGS

9.7.1 General

Decking shall be either spaced or continuous (i.e., without spacings).

There is no requirement to enclose the subfloor spaces of verandas, decks, steps, ramps or landings.

C9.7.1 Spaced decking is nominally spaced at 3 mm (in accordance with standard industry practice); however, due to the nature of timber decking with seasonal changes in moisture content, that spacing may range from 0–5 mm during service. The preferred dimension for gaps is 3 mm, which is in line with other 'permissible gaps', in other parts of this Standard. It should be noted that recent research studies have shown that gaps at 5 mm spacing afford opportunity for embers to become lodged in between timbers, which may contribute to a fire. Larger gap spacings of 10 mm may preclude this from happening but such a spacing regime may not be practical for a timber deck.

9.7.2 Enclosed subfloor spaces of verandas, decks, steps, ramps and landings

9.7.2.1 Materials to enclose a subfloor space

The subfloor spaces of verandas, decks, steps, ramps and landings are deemed to be 'enclosed' when—

- (a) the material used to enclose the subfloor space complies with Clause 9.4; and
- (b) all openings greater than 3 mm are screened with a mesh or perforated sheet with a maximum aperture of 2 mm, made of corrosion-resistant steel or bronze.

9.7.2.2 Supports

This Standard does not provide construction requirements for support posts, columns, stumps, stringers, piers and poles.

9.7.2.3 Framing

This Standard does not provide construction requirements for the framing of verandas, decks, ramps or landings (i.e., bearers and joists).

9.7.2.4 Decking

Decking shall have no gaps and be—

- (a) of non-combustible material; *or*
- (b) of fibre-cement sheet; *or*
- (c) a system complying with AS 1530.8.2; *or*
- (d) a combination of any of Items (a), (b) or (c) above.

9.7.3 Unenclosed subfloor spaces of verandas, decks, steps, ramps and landings

9.7.3.1 Supports

Support posts, columns, stumps, stringers, piers and poles shall be—

- (a) of non-combustible material; *or*
- (b) a system complying with AS 1530.8.2; *or*
- (c) a combination of Items (a) and (b) above.

9.7.3.2 Framing

Framing of verandas, decks, ramps or landings (i.e., bearers and joists) shall be—

- (a) of non-combustible material; *or*
- (b) a system complying with AS 1530.8.2; *or*
- (c) a combination of Items (a) and (b) above.

9.7.3.3 Decking

Decking shall have no gaps and be—

- (a) of non-combustible material; *or*
- (b) fibre-cement sheet; *or*
- (c) a system complying with AS 1530.8.2; *or*
- (d) a combination of Items (a), (b) or (c) above.

**9.7.4 Balustrades, handrails or other barriers**

Those parts of the handrails and balustrades less than 125 mm from any glazing shall be of non-combustible material.

Those parts of the handrails and balustrades that are 125 mm or more from the building have no requirements.

9.8 WATER AND GAS SUPPLY PIPES

Above-ground, exposed water and gas supply pipes shall be metal.



APPENDIX A
WORKED EXAMPLE FOR THE ASSESSMENT OF BUSHFIRE ATTACK
LEVEL (BAL)

(Informative)

A1 GENERAL

The following criteria forms the basis of the worked example shown in Paragraph A2 for bushfire category determination using Method 1, set out in Section 2. Table 2.4.3 has been selected as a basis for this worked example and inputs used are contained in Table 2.4.1:

- (a) Relevant FDI 80.
- (b) Flame temperature 1090 K.
- (c) Slope downslope >0 to 5 degrees.
- (d) Vegetation classification Forest.
- (e) Building location 40 m from the edge of the classified vegetation.

A2 WORKED EXAMPLE

For this worked example, the table used is for FDI 80. The relevant FDI, the slope (5 degrees), vegetation classification (forest) and distance of the site (40 m) from the classified vegetation have been highlighted in the table to follow. For this example, the determined Bushfire Attack Level is BAL—19.

TABLE A1
DETERMINATION OF BUSHFIRE ATTACK LEVEL (BAL) FDI 80 (1090 K)

Vegetation classification	Bushfire Attack Levels (BAL)				
	BAL—FZ	BAL—40	BAL—29	BAL—19	BAL—12.5
	Distance (m) of the site from the predominant vegetation class				
	All upslopes and flat land (0 degrees)				
A. Forest	<16	16—<21	21—<31	31—<42	42—<100
B. Woodland	<10	10—<14	14—<20	20—<29	29—<100
C. Shrubland	<10	10—<13	13—<19	19—<27	27—<100
D. Scrub	<7	7—<9	9—<13	13—<19	19—<100
E. Mallee/Mulga	<6	6—<8	8—<12	12—<17	17—<100
F. Rainforest	<6	6—<9	9—<13	13—<19	19—<100
Downslope >0 to 5 degrees					
A. Forest	<20	20—<27	27—<37	37—<50	50—<100
B. Woodland	<13	13—<17	17—<25	25—<35	35—<100
C. Shrubland	<11	11—<15	15—<22	22—<31	31—<100
D. Scrub	<7	7—<10	10—<15	15—<22	22—<100
E. Mallee/Mulga	<7	7—<9	9—<13	13—<20	20—<100
F. Rainforest	<8	8—<11	11—<17	17—<24	24—<100
Downslope >5 to 10 degrees					
A. Forest	<26	26—<33	33—<46	46—<61	61—<100
B. Woodland	<16	16—<22	22—<31	31—<43	43—<100
C. Shrubland	<12	12—<17	17—<24	24—<35	35—<100
D. Scrub	<8	8—<11	11—<17	17—<25	25—<100
E. Mallee/Mulga	<7	7—<10	10—<15	15—<23	23—<100
F. Rainforest	<11	11—<15	15—<22	22—<31	31—<100
Downslope >10 to 15 degrees					
A. Forest	<33	33—<42	42—<56	56—<73	73—<100
B. Woodland	<21	21—<28	28—<39	39—<53	53—<100
C. Shrubland	<14	14—<19	19—<28	28—<39	39—<100
D. Scrub	<9	9—<13	13—<19	19—<28	28—<100
E. Mallee/Mulga	<8	8—<11	11—<18	18—<26	26—<100
F. Rainforest	<14	14—<19	19—<28	28—<39	39—<100
Downslope >15 to 20 degrees					
A. Forest	<42	42—<52	52—<68	68—<87	87—<100
B. Woodland	<27	27—<35	35—<48	48—<64	64—<100
C. Shrubland	<15	15—<21	21—<31	31—<43	43—<100
D. Scrub	<10	10—<15	15—<22	22—<31	31—<100
E. Mallee/Mulga	<9	9—<13	13—<20	20—<29	29—<100
F. Rainforest	<18	18—<25	25—<36	36—<48	48—<100

APPENDIX B

DETAILED METHOD FOR DETERMINING THE BUSHFIRE ATTACK LEVEL (BAL)—METHOD 2

(Normative)

B1 GENERAL

The following procedure shall apply to determine the category of bushfire attack on a detailed basis for all circumstances where the effective slope under the classified vegetation is no more than 30 degrees downslope and the slope of the land between the site and the classified vegetation is no more than 20 degrees, regardless of slope type:

- (a) Step 1: Determine the relevant FDI or wind speed in accordance with Paragraph B2.
- (b) Step 2: Determine the vegetation classification, fuel loads and vegetation height in accordance with Paragraph B3.
- (c) Step 3: Determine the effective slope under the classified vegetation in accordance with Paragraph B4.
- (d) Step 4: Determine the slope, in degrees, of the land between the site and the classified vegetation in accordance with Paragraph B5.
- (e) Step 5: Determine the distance of the site from classified vegetation in accordance with Paragraph B6.
- (f) Step 6: Calculate the flame length in accordance with Paragraph B7.
- (g) Step 7: Determine flame width in accordance with Paragraph B8.
- (h) Step 8: Determine the elevation of receiver in accordance with Paragraph B9.
- (i) Step 9: Calculate the radiant heat flux in accordance with Paragraph B10.
- (j) Step 10: Determine the category of bushfire attack in accordance Paragraph B11.

***CB1** The reason why the effective slope under the classified vegetation is limited to 30 degrees downslope (Ref. 1) is that convective heat from bushfire flames is no longer negligible and the relationship used to adjust the forward rate of spread for the effective slope becomes inapplicable when the effective slope is over the 30 degrees downslope limit (Ref. 2).*

The reason why the slope of the land between the site and the classified vegetation is limited to 20 degrees is that the establishment and the maintenance of the setback between the site and the vegetation may become impractical when the slope of the land between the site and the classified vegetation is over 20 degrees (Ref. 3).

B2 STEP 1—RELEVANT FDI OR WIND SPEED

Determine the relevant FDI or wind speed as follows:

- (a) For forests, woodlands, rainforest and other forest group vegetation classifications, determine the relevant Forest Fire Danger Index (FDI) for the site in accordance with Clause 2.3 or obtain other data sets provided by the authority having jurisdiction for the site.
- (b) For heath, shrub and scrub vegetation classifications, a nominal value of 45 km/h shall be used for wind speed to determine rate of spread.

NOTE: Wind speeds are measured and reported for a height of 10 m above ground level.

B3 STEP 2—VEGETATION CLASSIFICATION

Determine the vegetation classification—

- (a) in accordance with Clause 2.4; and
- (b) select the appropriate potential surface fuel load (w), overall fuel load (W) and classified vegetation height (VH) from Table B2 or other data sets provided by the relevant fire authority for the site.

NOTE: Both the understorey and the canopy should be considered in the assessment. The rate of spread for forest fires should be determined using the understorey fuel loads. Flame heights should be determined on the basis of both the combined understorey and canopy fuels (overall fuel loads) for forest fires.

CB3 The vegetation classification system in Section 2 and in this Appendix is based on a national system developed by R. Specht (Ref. 4). Some States and Territories have developed their own systems for vegetation classification, which may vary in extent or description to those provided herein.

For example, in NSW, a system has been established by D. Keith (Ref. 5) and fuel loads have been extensively researched for that State. This may not be comparable to other States/Territories, which may have significantly different fuel loads or different descriptions for a similar vegetation classification.

Consultation with relevant fire authorities is important to establish any variations from the values provided in Table B2 below.

B4 STEP 3—EFFECTIVE SLOPE UNDER THE CLASSIFIED VEGETATION

Determine the effective slope (in degrees) under the classified vegetation in accordance with Clause 2.6.

CB4 The effective slope under the classified vegetation is not the same as average slope for the land surrounding the site of the proposed building. The effective slope is that slope which most significantly influences fire behaviour. For example, two slopes may occur in an area, one downslope and one upslope, but together they average as 0 degrees, where in practice one of the slopes will influence fire behaviour. In some cases, rocky shelf faces without vegetation cannot influence fire behaviour whereas the shelf slope itself can. In some cases, effective slope will have to be determined by survey.

B5 STEP 4—SLOPE BETWEEN SITE AND CLASSIFIED VEGETATION

Determine the slope (in degrees) of the ground between the site and the classified vegetation (Point B to Point A, see Figure 2.1).

CB5 The slope between the site and the classified vegetation has an effect on the 'view factor' determined for a given position. It is the slope along the ground by line of sight between the predominant vegetation and the site.

B6 STEP 5—DISTANCE OF THE SITE FROM CLASSIFIED VEGETATION

Determine the distance (in plan view) of the site from the classified vegetation (Point A to Point B, see Figure 2.1) in accordance with Clause 2.5.

B7 STEP 6—FLAME LENGTH

Flame length shall be calculated as follows:

- (a) Apply an appropriate fire behaviour equation in Table B1, based on the vegetation classification and corresponding fuel loads determined in Paragraph B3 above, to obtain a value for the forward rate of spread of the fire (R).
- (b) Correct the forward rate of spread of the fire (R) for effective slope using the following rules (Ref. 6):

$$R_{\text{slope}} = R \exp(0.069 \text{ slope}) \quad \text{for downslope}$$

$$R_{\text{slope}} = R \exp(-0.069 \text{ slope}) \quad \text{for level or upslope (see Commentary CB7)}$$

where

$$R_{\text{slope}} = \text{forward rate of spread adjusted for effective slope (km/h)}$$

$$R = \text{forward rate of spread (km/h), determined in Item (a)}$$

$$\text{slope} = \text{effective slope (degrees), determined in Paragraph B4 above}$$

- (c) Go to Item (d) below if the fuel type associated with the vegetation classification determined in Clause B3 is Forest or Woodlands; otherwise calculate the fire intensity (I) in kW/m in using:

$$I = HW R_{\text{slope}}/36 \quad (\text{Ref. 7}) \quad \dots \text{B1}$$

where

$$H = \text{heat of combustion (18 600 kJ/kg)}$$

$$W = \text{overall fuel load (t/ha), determined in Paragraph B3 above}$$

$$R_{\text{slope}} = \text{adjusted forward rate of spread (km/h), determined in Paragraph B7(b)}$$

- (d) Calculate flame length (L_f)—

For Forest or Woodlands (Rainforest and other forest forms):

$$L_f = [13 R_{\text{slope}} + 0.24W]/2 \quad (\text{Ref. 3}) \quad \dots \text{B2}$$

where

$$R_{\text{slope}} = \text{forward rate of spread adjusted for slope (km/h)}$$

$$W = \text{overall fuel load (t/ha), determined in Paragraph B3 above}$$

For Shrub and Heath or Mallee and Mulga or Tussock moorland:

$$L_f = 0.0775I^{0.46} \quad (\text{Ref. 7}) \quad \dots \text{B3}$$

where

$$I = \text{fireline intensity (kW/m)}$$

CB7 The bushfire behaviour equations predict the head fire behaviour and are empirical in nature. These equations may not be accurate in all situations due to (a) their empirical nature and (b) the extrapolation of them beyond the original conditions under which they were developed.

Flame length (L_f) is taken as the sustained flame length, which adjusts the standard flame length equation for forest type vegetation (Ref. 6) reducing it by half, which takes into account flame discontinuity and adjusting for lower flame temperatures and flame geometry.

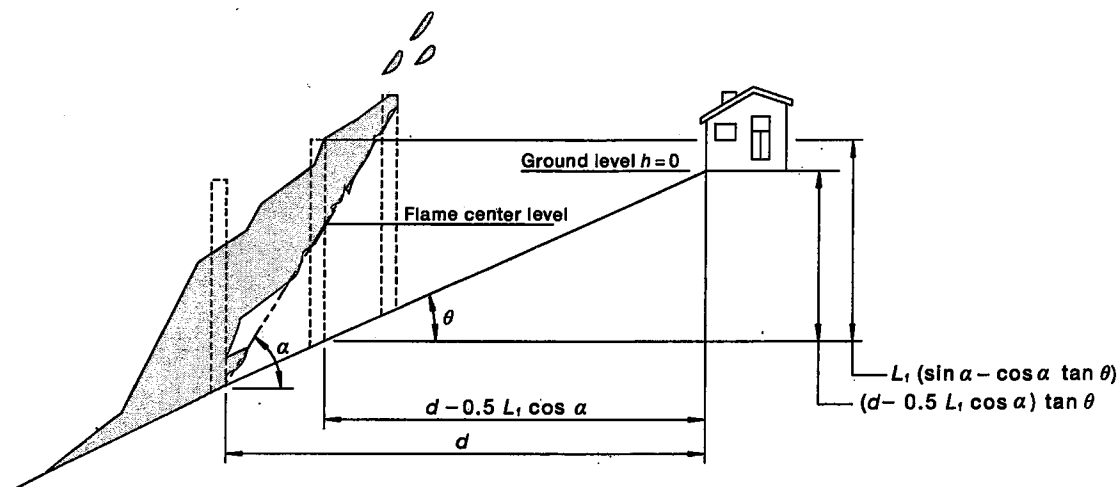

FIGURE B2 FLAME CENTRE LOWER THAN GROUND

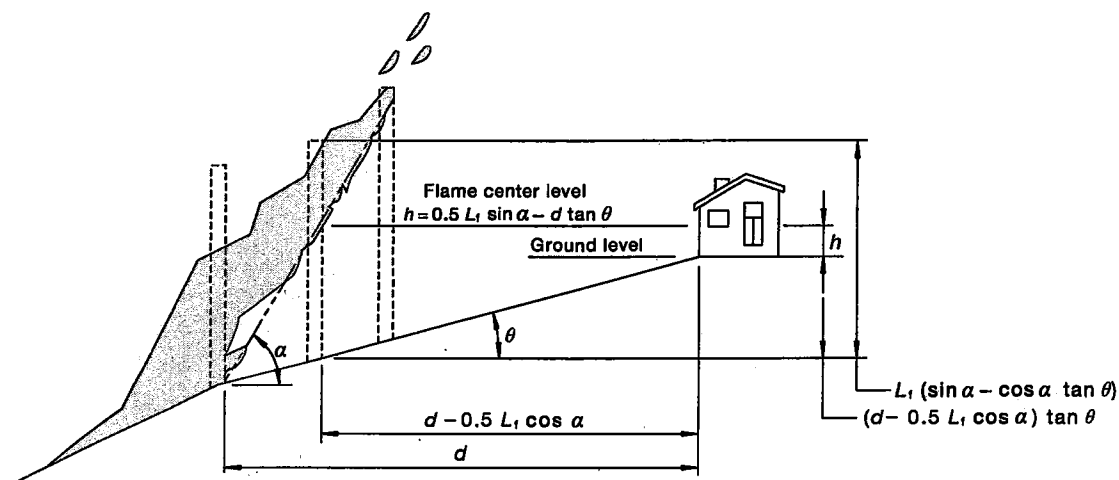

FIGURE B3 FLAME CENTRE HIGHER THAN GROUND

B10 STEP 9—RADIANT HEAT FLUX

B10.1 General

The radiant heat flux (q) in kW/m^2 to which the site might be exposed shall be calculated using the radiant heat transfer law with atmospheric transmissivity correction, as follows:

$$q = \tau \phi E \quad \dots \text{B4}$$

where

E = flame emissive power (kW/m^2), determined in accordance with Paragraph B10.2

ϕ = view factor, determined in accordance with Paragraph B10.3

τ = atmospheric transmissivity, determined in accordance with Paragraph B10.4

B10.2 Flame emissive power

Flame emissive power (E) shall be calculated using the Stefan–Boltzmann equation, as follows:

$$E = \sigma \varepsilon T_f^4 \quad (\text{Ref. 8}) \quad \dots \text{B5}$$

where

σ = Stefan–Boltzmann constant ($5.67 \times 10^{-11} \text{ kW/m}^2\text{K}^{-4}$)

ε = flame emissivity (assumes 0.95) (see Commentary CB10.2)

T_f = flame temperature (see Commentary CB10.2)

CB10.2 *The application of the Stefan–Boltzmann equation is based on the assumptions that a bushfire flame emits radiation at a surface and that flame temperature and emissivity are uniform across the whole flame surface (Ref. 9).*

The above assumptions are generally justified considering that the overwhelming difficulty associated with the accurate measurement of flame temperatures and flame emissivity in both laboratory and field environments as well as the level of the uncertainty resulting from the flame length modelling with the existing empirical bushfire behaviour equations.

The prediction of flame emissive power using the Stefan–Boltzmann equation necessitates the knowledge of the temperature (T_f) of the emitting flame and its emissivity (ε). A nominal flame emissivity of 0.95 is considered to be justified as the bushfire flames under design fire weather scenarios are generally optically thick ($\varepsilon \approx 1$).

The predicted flame emissive power is very sensitive to flame temperature. Therefore the selection of the nominal flame temperature for calculation is critical to make sure that the construction standard determined with this flame temperature together with other input parameters can provide an adequate level of stringency or safety at a reasonable cost.

The existing scientific literature suggests that flame temperatures for determining flame emissive power vary greatly and the majority of them fall within a range between 1000 K and 1200 K (Ref. 10). An appropriate flame temperature is chosen from the above range in accordance with the minimum level of stringency or safety required by the relevant authority having jurisdiction.

B10.3 View factor

View factor or configuration factor is a geometrical factor required by calculating the radiant heat flux to which a site might be exposed, which is a function of flame geometry, location of radiant heat flux receiving element i.e. radiation receiver and relative orientation between the flame and the receiver. For the tilted flame shown in Figure B4, the view factor (ϕ) shall be calculated using one of the following:

- (a) If $d \leq 0.5L_f \cos \alpha$, then $\phi = 1$

or

(b) if $d > 0.5L_f \cos \alpha$, then

$$\phi = \frac{1}{\pi} \left\{ \frac{X_1}{\sqrt{1+X_1^2}} \tan^{-1} \left[\frac{Y_1}{\sqrt{1+X_1^2}} \right] + \frac{Y_1}{\sqrt{1+Y_1^2}} \tan^{-1} \left[\frac{X_1}{\sqrt{1+Y_1^2}} \right] + \right. \\ \left. \frac{X_2}{\sqrt{1+X_2^2}} \tan^{-1} \left[\frac{Y_2}{\sqrt{1+X_2^2}} \right] + \frac{Y_2}{\sqrt{1+Y_2^2}} \tan^{-1} \left[\frac{X_2}{\sqrt{1+Y_2^2}} \right] \right\} \quad \dots \text{B6}$$

$$X_1 = (L_f \sin \alpha - 0.5L_f \cos \alpha \tan \theta - d \tan \theta - h)/(d - 0.5L_f \cos \alpha)$$

$$X_2 = [h + (d - 0.5L_f \cos \alpha) \tan \theta]/(d - 0.5L_f \cos \alpha)$$

$$Y_1 = Y_2 = 0.5W_f/(d - 0.5L_f \cos \alpha)$$

where

L_f = flame length (m), determined in Paragraph B7

W_f = flame width, determined in Paragraph B8

α = flame angle (degrees), determined using the algorithm in Figure B5

θ = slope of the land between the site and the classified vegetation (degrees), determined in Paragraph B5

d = distance between the site and classified vegetation (m), determined in Paragraph B6

h = elevation of receiver (m), determined in Paragraph B9

The calculation of view factor requires the knowledge of flame length, flame width, flame angle, slope of the land between the site and the classified vegetation, distance of the site from classified vegetation, and elevation of receiver. When flame length, flame width, slope of the land between the site and the classified vegetation, distance of the site from classified vegetation and elevation of receiver are given, view factor changes with flame angle only and reaches the maximum for a flame angle between the minimum and the maximum. It is this maximum view factor that shall be used to calculate radiant heat flux so that the potential risk associated with flame angle is minimized.

The maximum view factor and the corresponding flame angle may be determined using the algorithm shown in Figure B5.

CB10.3 *The derivation of the view factor equation is based on the following assumptions:*

Assumption 1: *The view factor of an inclined flame can be approximated by that of a vertical flame with the same flame height located in the middle of the inclined flame. This assumption enables the flame tilt effect to be taken into account and it is justified by the CSIRO's laboratory experimental research findings (Ref. 11).*

Assumption 2: *The radiant heat flux receiver is aligned with the vertical axis of the flame and it is paralleled to the equivalent vertical flame located in the middle of the inclined flame (see Figure B1).*

The above assumptions represent a potential worst case scenario and therefore a safety factor has been implicitly incorporated into the determination of view factor.

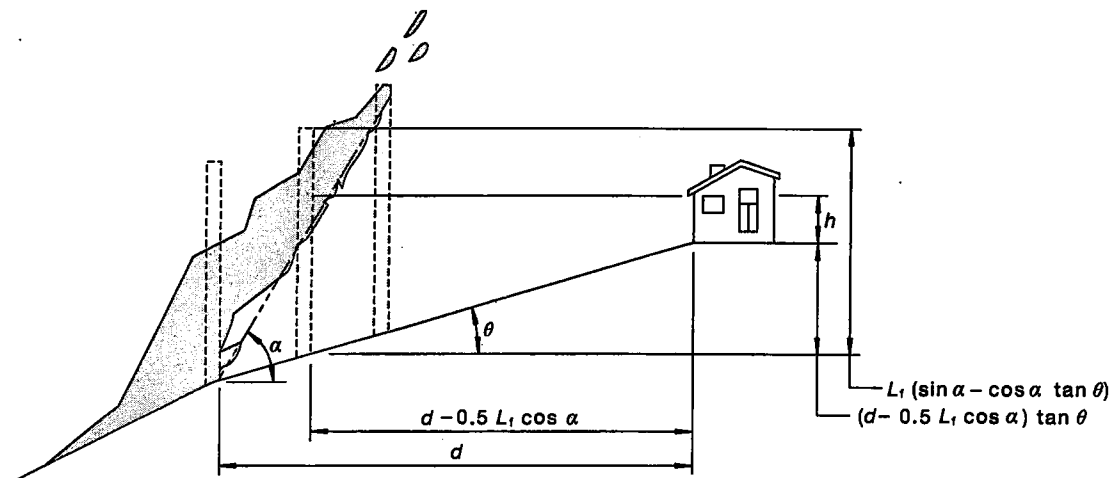
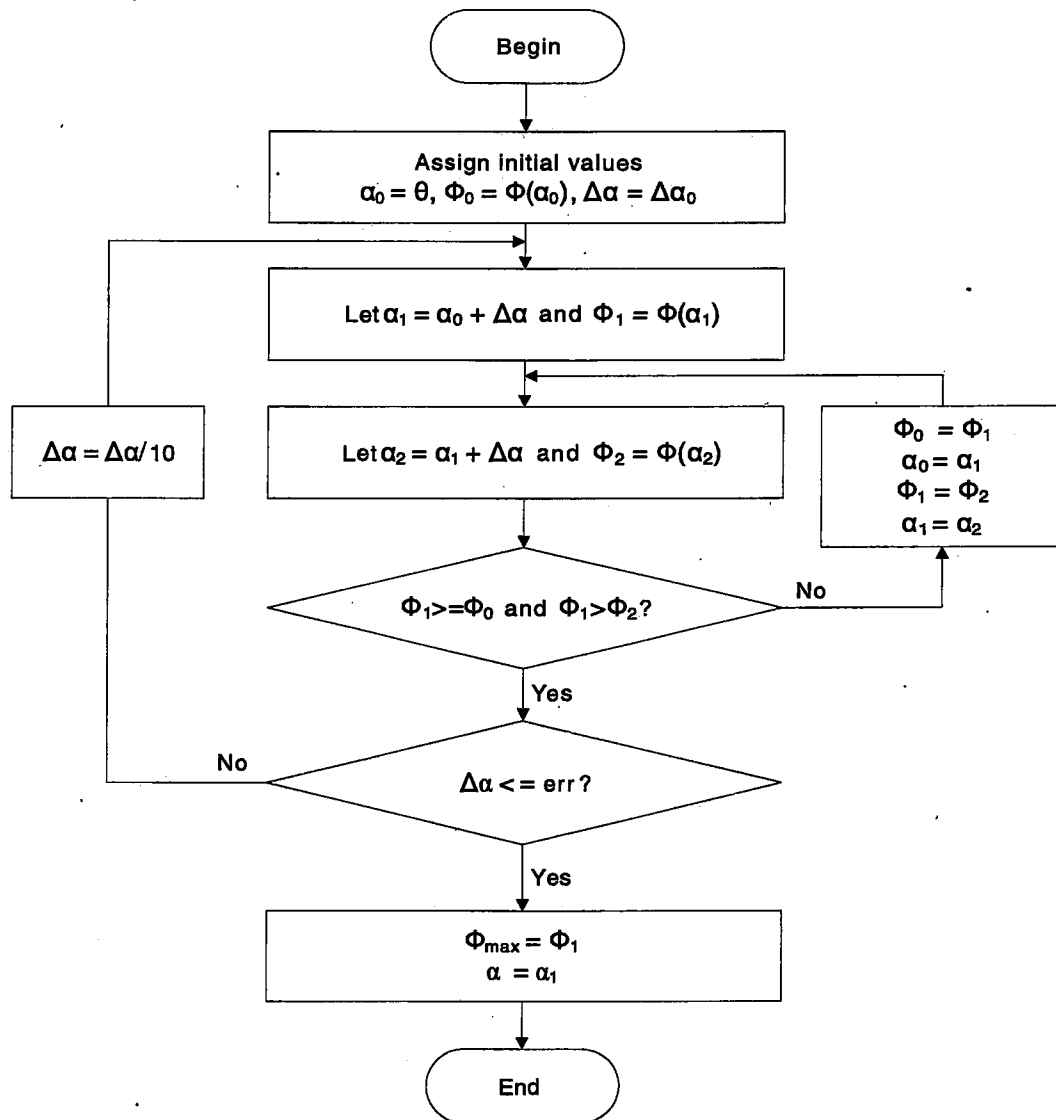

FIGURE B4 DIAGRAM FOR CALCULATING VIEW FACTOR



NOTE: The accuracy of the maximum view factor (Φ_{\max}) and the corresponding flame angle (α) determined using the algorithm in Figure B5 depends on the calculation error (err) specified for flame angle. A calculation error of 1 degree (i.e., err = 1) is usually considered to be adequate. The initial flame angle increment ($\Delta\alpha_0$) together with the predefined calculation error determines the number of iterations that need to be performed to achieve the expected calculation accuracy. If the calculation error is limited to 1 degree, then the flame angle increment ($\Delta\alpha$) may start with 10 degrees ($\Delta\alpha_0 = 10$).

FIGURE B5 FLOW DIAGRAM FOR DETERMINING MAXIMUM VIEW FACTOR AND THE CORRESPONDING FLAME ANGLE

B10.4 Atmospheric transmissivity

Atmospheric transmissivity is calculated using an empirical approach (Ref. 12), which involves the following steps:

(a) Calculate path length (L) from the following:

(i) $L = 0$ if $d \leq 0.5L_f \cos\alpha$

or

(ii) $L = d - 0.5L_f \cos\alpha$

where

d = distance between the site and classified vegetation (m),
determined in Paragraph B6

L_f = flame length (m), determined in Paragraph B7

α = flame angle (degrees), determined in Paragraph B10.3

(b) Calculate coefficient (a_n)—

$$a_n = C_{1n} + C_{2n}T_a + C_{3n}T_f + C_{4n}RH \quad \dots B8$$

where

T_a = ambient temperature (assumes 308 K)

T_f = flame temperature, see Paragraph B10.2

RH = relative humidity (assumes 25%)

C_{1n}, C_{2n}, C_{3n} = constants defined in Table B3
and C_{4n}

(c) Calculate atmospheric transmissivity (τ) from the following:

(i) If $L = 0$, then $\tau = 1$

or

(ii) If $L \neq 0$, then $\tau = a_0 + a_1L + a_2L^2 + a_3L^3 + a_4L^4$

where

L = path length (m), determined in Paragraph B10.4(a)

a_n = coefficient determined in Paragraph B10.4(b)

B11 STEP 10—DETERMINE THE CATEGORY OF BUSHFIRE ATTACK

The category of bushfire attack and the associated construction requirements shall be determined as follows:

- (a) The category of bushfire attack shall be determined in accordance with Table 3.1.
- (b) The deemed to satisfy construction requirements corresponding to the category of bushfire attack determined in Item (a) shall be determined in accordance with the procedure shown in Figure 1.1.

TABLE B1
VEGETATION TYPES, FUEL TYPES, AND
CORRESPONDING FIRE BEHAVIOUR MODELS

Fuel types	Fire model	Fire behaviour equation
Forest and Woodland	McArthur, 1973 and Noble et al, 1980	$R = 0.0012 * FDI * w$
Shrub and Heath	Catchpole et al. 1998	$R = 0.023 * V^{1.21} * VH^{0.54}$
Tussock moorland	Marsden-Smedley et al.1995	$R = 0.024 * V^{1.312} * \exp(-0.0243 * M_f) * (1 - \exp(-0.116 * \text{age}))$

LEGEND:

R = rate of spread (km/h)

FDI = McArthur Fire Danger Index and is dimensionless

w = surface fuel load (t/ha)

VH = average height of classified vegetation (m)

V = average wind speed at 10 m above ground (km/h)

M_f = moisture factor used for Tussock moorland only and is dimensionless

age = age of vegetation used for Tussock moorland only (yrs)

TABLE B2
VEGETATION CLASSIFICATION AND FUEL LOAD

Vegetation classification (see Clause 2.2.3)	Vegetation type (see Figure 2.3)	Fuel type	Surface fuel load (t/ha)	Overall fuel load (t/ha)	Vegetation height (m)
Forests	2,3,5	Forest	25	35	—
Woodlands	6,7,9,10,11	Woodlands	15	25	—
Closed shrub	12,13	Shrub and heath	25	25	3
Open shrub	16,17,18	Shrub and heath	15	15	1.5
Mallee/Mulga	14,15	Shrub and Heath	8	8	3
Rainforest	1,4,8	Forest	10	12	—
Tussock moorland	21,22	Tussock moorland	17	17	$M_f = 5$ age = 20 y

TABLE B3
CONSTANTS TO CALCULATE COEFFICIENT a_n

n	C_{1n}	C_{2n}	C_{3n}	C_{4n}
0	1.486	-2.003×10^{-3}	4.68×10^{-5}	-6.052×10^{-2}
1	1.225×10^{-2}	-5.900×10^{-5}	1.66×10^{-6}	-1.759×10^{-3}
2	-1.489×10^{-4}	6.893×10^{-7}	-1.922×10^{-8}	2.092×10^{-5}
3	8.381×10^{-7}	-3.823×10^{-9}	1.0511×10^{-10}	-1.166×10^{-7}
4	-1.685×10^{-9}	7.637×10^{-12}	-2.085×10^{-13}	2.350×10^{-10}

REFERENCES

- 1 TOLHURST, K.G. AND HOWLETT, K.A. *House Ignition Likelihood Index—An Hazard Assessment Method for Land Managers in the Wildland-Urban Interface*. In '10th AFAC Conference and 4th International Wildland Fire Conference', Sydney, Australia: 2003.
- 2 CHENEY, N.P. *Fire Behaviour in 'Fire and Australian Biota'* (Ed. GILL, A.M., GROVES, R.H. and NOBLE, I.R.), Australia Academy of Science, Canberra: 1981.
- 3 NSW RURAL FIRE SERVICE. *Planning For Bushfire Protection—A Guide for Councils, Planners, Fire Authorities, Developers and Home Owners*, NSW RFS, Sydney: 2001.
- 4 SPECHT, R. 1970. *The Australian Environment*, LEEPER, G.W. (ed.) 4th edition: Carlton, Melbourne University Press, 1970, Chapter 5, Vegetation. pp.45-67. CSIRO Press.
- 5 KEITH, D.A., *Ocean Shores to Desert Dunes; the native vegetation of New South Wales and the ACT*. NSW Department of Environment and Conservation (2004).
- 6 NOBLE, I.R., BARY, G.A.V. and GILL, A.M. *McArthur's fire-danger meters expressed as equations*. Aust. J. Ecology 5: 1980. 201-203 pp.
- 7 BYRAM, G.M. *Combustion of Forest Fuels*. In: 'Forest Fire Control and Use' (Ed. DAVIS, K.P.) McGraw-Hill, New York: 1959.
- 8 DRYSDALE, D. *An Introduction to Fire Dynamics* (2nd Edition), John Wiley and Sons: 1999. 424 pp.
- 9 KNIGHT, I.K. and SULLIVAN, A.L. *A Semi-transparent Model of Bushfire Flames to Predict Radiant Heat Flux*, Int. J. Wildland Fire: 2004 (13):201-207 pp.
- 10 VINES, R.G. *Physics and Chemistry of Rural Fires in 'Fire and Australian Biota'* (Ed. GILL, A.M., GROVES, R.H. and NOBLE, I.R.), Australia Academy of Science, Canberra: 1981.
- 11 SULLIVAN, A.L., ELLIS, P.F. AND KNIGHT, I.K. *A Review of Radiant Heat Flux Models Used In Bushfire Applications*. *International Journal of Wildland Fire*: 2003 (12): 101-110 pp.
- 12 FUSS, S.P. and HAMINS, A. *An Estimate of the Correction Applied to Radiant Flame Measurements Due to Attenuation by Atmospheric CO₂ And H₂O*. *Fire Safety Journal* (37):2002. 181-190 pp.
- 13 CATCHPOLE, W.R., BRADSTOCK, R.A., CHOATE, J., FOGARTY, L.G., GELLIE, N., McCARTHY, G.J., McCAW, W.L., MARSDEN-SMEDLEY, J.B. and PEARCE, G. *Co-operative Development of Equations for Heathland Fire Behaviour*. In 'Proc. 3rd Int. Conf. Forest Fire Research and 14th Conf. on Fire and Forest Meteorology'. (Ed. VIEGAS, D.X.) Luso, Coimbra, Portugal: 1998. 631-645 pp.
- 14 LUKE, R.H. *Hazard reduction for the protection of buildings in bushland areas*. NSW Fire Brigades, Sydney: 1982.
- 15 MARSDEN-SMEDLEY, J.B. and CATCHPOLE, W.R., *Buttongrass moorland Fire Behaviour Modelling in Tasmanian Buttongrass Moorlands II*. *Fire Behaviour, International Journal of Wildland Fire*: 1995 (4):215-228 pp.

APPENDIX C
PROCESS AND PROCEDURE FOR DETERMINING THE BUSHFIRE ATTACK
LEVEL (BAL)
(Informative)

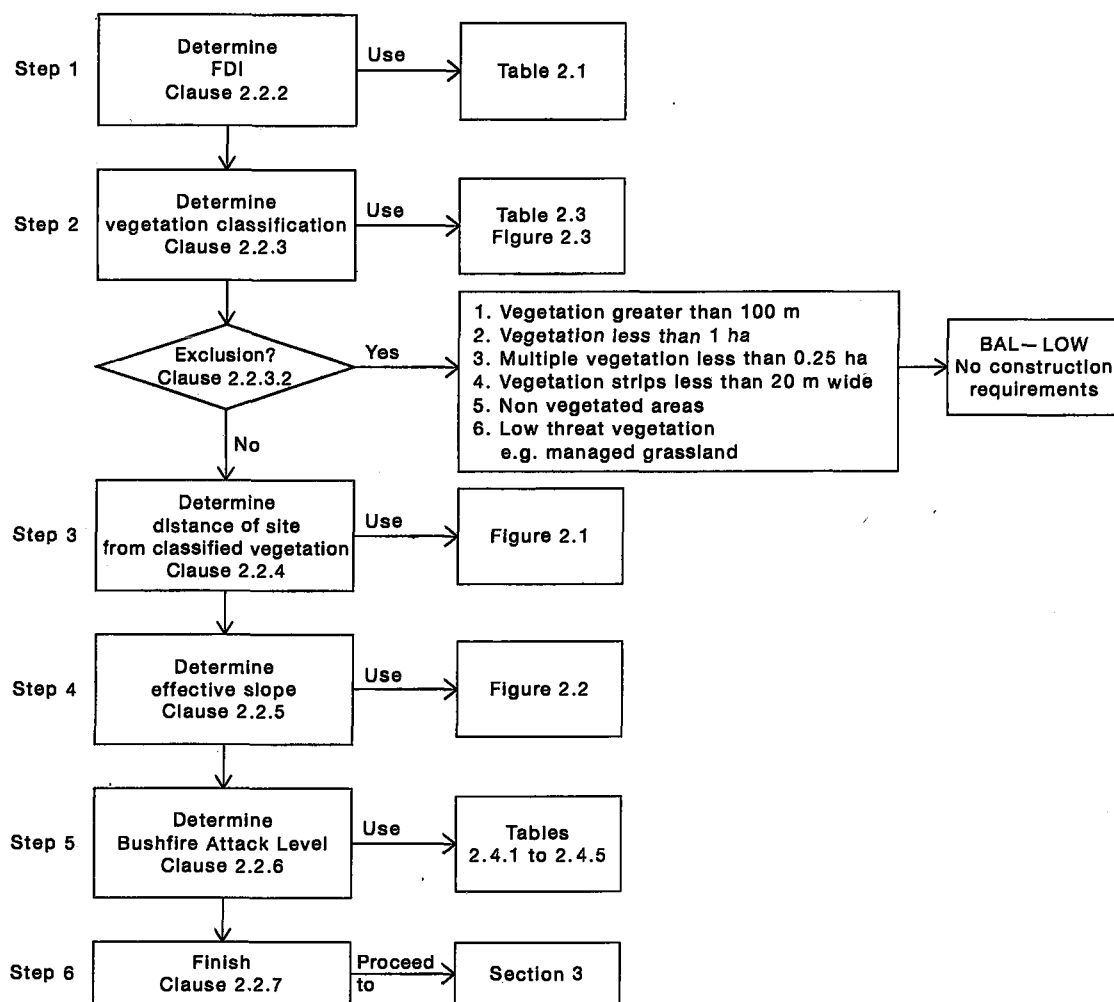
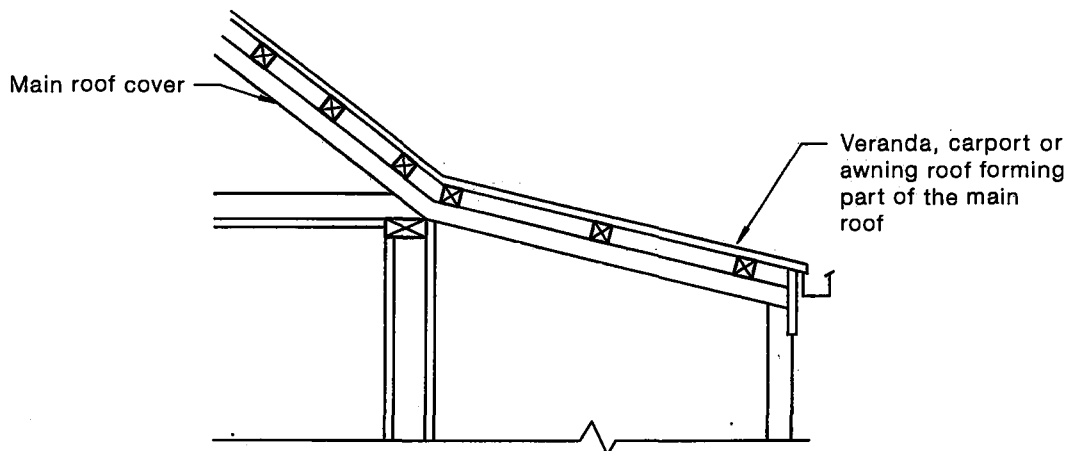

FIGURE C1 DETERMINATION OF THE BUSHFIRE ATTACK LEVEL (BAL)—METHOD 1

APPENDIX D
ILLUSTRATIONS
(Normative)

The following illustrations (Figures D1 to D4) support requirements of this Standard:



(a) Continuous roof

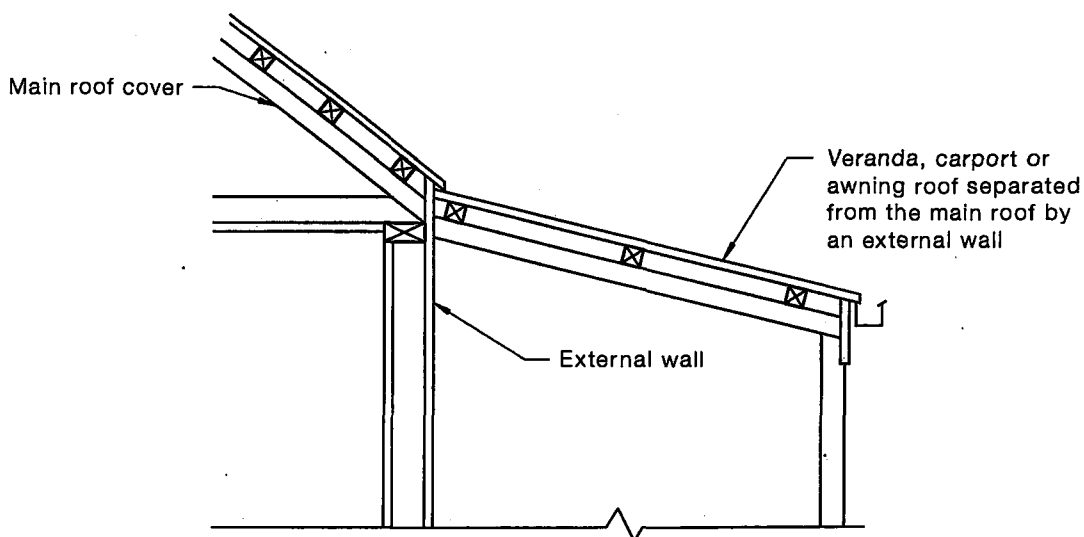

(b) Continuous roof with veranda, carport or awning roof separated from main roof

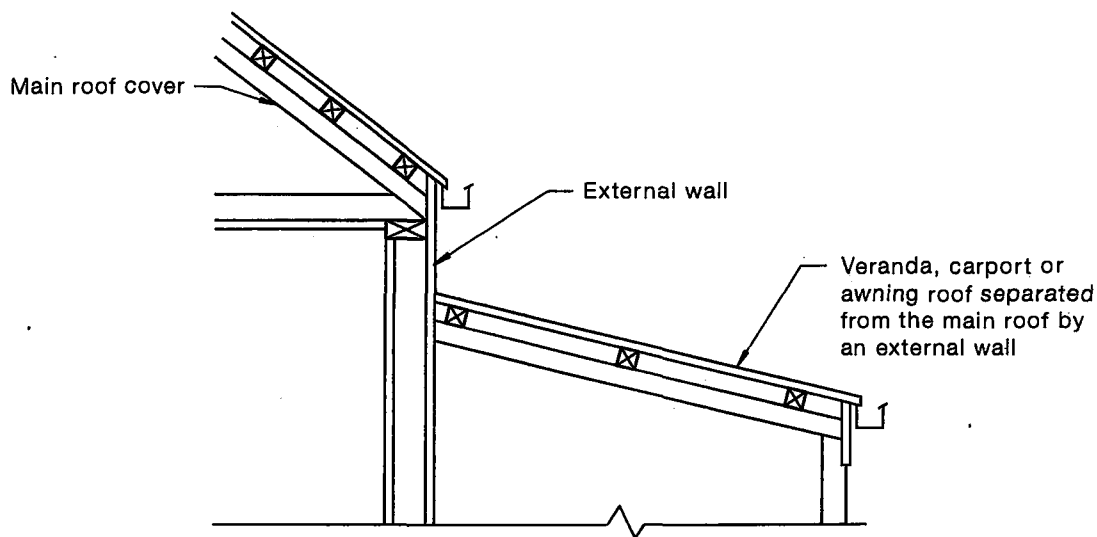

(c) Discontinuous roof

FIGURE D1 VERANDA, CARPORT OR AWNING ROOFS SHOWING CONTINUOUS AND DISCONTINUOUS ROOF TYPES

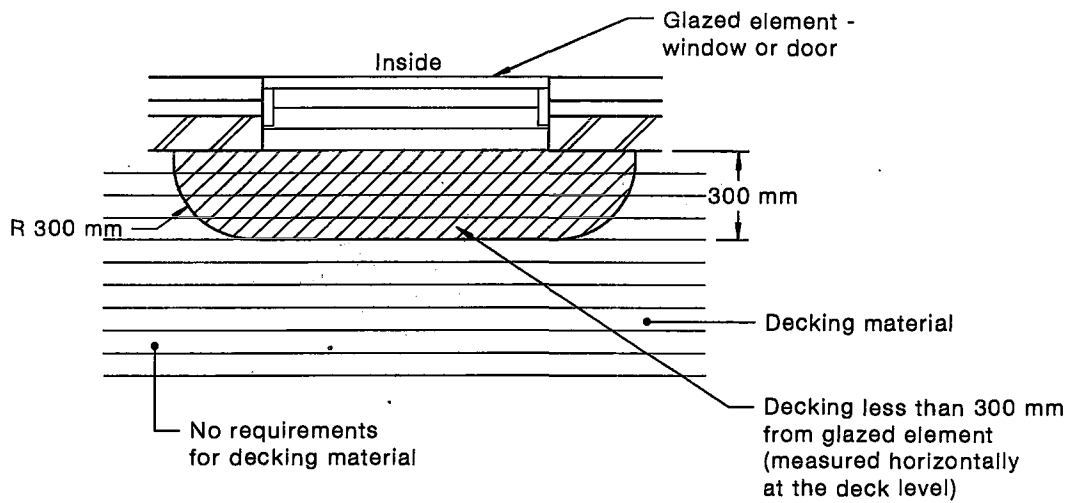

(a) Plan view

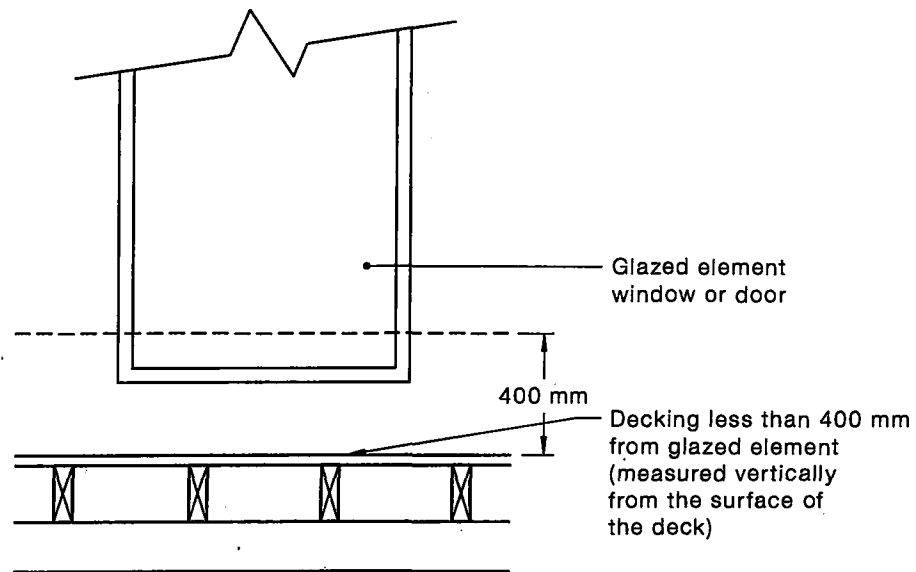

(b) Elevation view

DIMENSIONS IN MILLIMETRES

FIGURE D2 DECKING WITHIN HORIZONTAL AND VERTICAL LIMITS OF GLAZED ELEMENTS

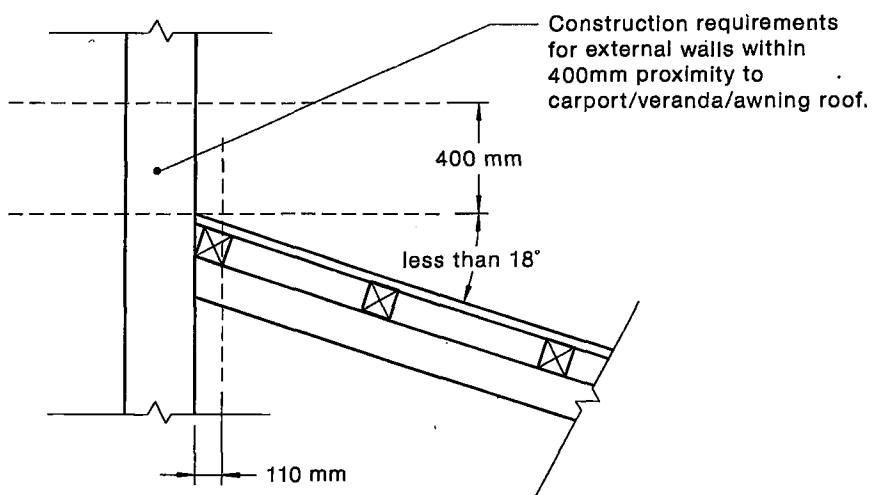
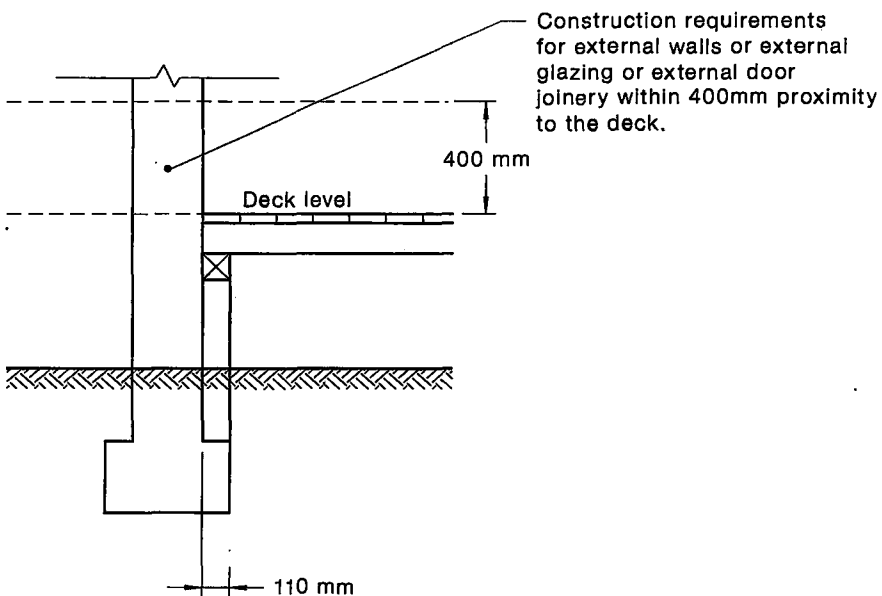
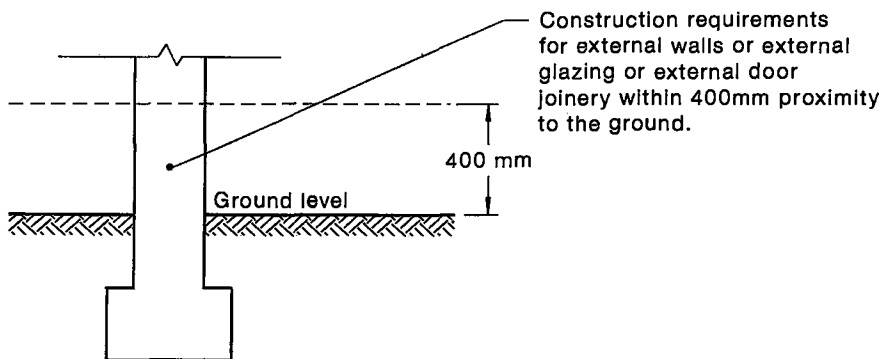

DIMENSIONS IN MILLIMETRES

FIGURE D3 EXTERNAL WALLS OR EXTERNAL GLAZING, OR EXTERNAL DOORFRAMES WITHIN LIMITS ABOVE GROUND, DECKS, CARPORT ROOFS

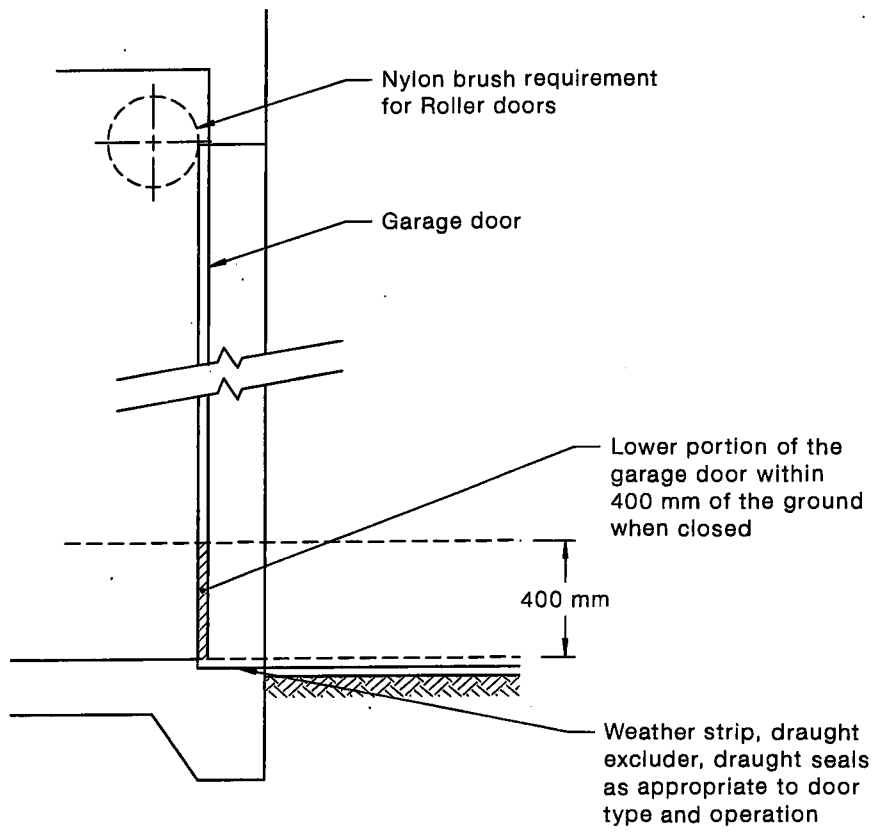

FIGURE D4 VEHICLE ACCESS DOORS (GARAGE DOORS)

APPENDIX E
TIMBER SPECIES AND DENSITIES
(Normative)

E1 GENERAL CONSTRUCTION

Timber with a density of 750 kg/m³ or greater at a 12 percent moisture content is suitable for construction where specified in Sections 5, 6 and 7. Examples of suitable timber species are listed in Table E1.

Densities of timber species not listed in Table E1 may be found in AS 1720.2.

Many of the timber species listed in Table E1 from various regions of Australia may not be available in all areas.

TABLE E1
TIMBER SPECIES WITH A DENSITY OF
750 kg/m³ OR GREATER

Standard trade name	Botanical name
Ash, Crow's	Flindersia australis
Ash, silvertop	Eucalyptus sieberi
Balau (selangan batu)	Shorea spp.
Bangkirai	Shorea laevifolia
Belian	Eusideroxylon zwageri
Blackbutt	Eucalyptus pilularis
Blackbutt, New England	Eucalyptus andrewsii
Box, brush	Lophosteman confertus
Box, grey	Eucalyptus microcarpa
Box, grey, coast	Eucalyptus bosistoana
Box, white-topped	Eucalyptus quadrangulata
Box, yellow	Eucalyptus melliodora
Brownbarrel	Eucalyptus fastigata
Candlebark	Eucalyptus rubida
Gum, blue, southern	Eucalyptus globulus
Gum, blue, Sydney	Eucalyptus saligna
Gum, grey	Eucalyptus propinqua
Gum, grey, mountain	Eucalyptus cypellocarpa
Gum Maiden's	Eucalyptus maidenii
Gum, manna	Eucalyptus viminalis
Gum, red, forest	Eucalyptus teteticornis
Gum, red, river	Eucalyptus camaldulensis
Gum, rose	Eucalyptus grandis

(continued)

TABLE E1 (continued)

Standard trade name	Botanical name
Gum, spotted	<i>Corymbia maculata</i>
	<i>Corymbia henryi</i>
	<i>Corymbia citriodora</i>
Gum, sugar	<i>Eucalyptus cladocalyx</i>
Hardwood, Johnstone River	<i>Backhousia bancroftii</i>
Ironbark, grey	<i>Eucalyptus paniculata</i>
Ironbark, red	<i>Eucalyptus sideroxylon</i>
Jarrah	<i>Eucalyptus marginata</i>
Kapur	<i>Dryobalanops</i> spp.
Karri	<i>Eucalyptus diversicolor</i>
Kempas	<i>Koompassia malaccensis</i>
Keruing	<i>Dipterocarpus</i> spp.
Kwila (Merbau)	<i>Intsia bijuga</i>
Mahogany red	<i>Eucalyptus resinifera</i>
Mahogany, southern	<i>Eucalyptus botryoides</i>
Mahogany, white	<i>Eucalyptus acmenoides</i>
Messmate	<i>Eucalyptus obliqua</i>
Messmate, Gympie	<i>Eucalyptus cloeziana</i>
Northern Box (Pelawan)	<i>Tristaniopsis</i> spp.
Oak, American	<i>Quercus</i> spp.
Peppermint, narrow-leaved	<i>Eucalyptus australiana</i>
Satinay	<i>Syncarpia hillii</i>
Stringybark, Blackdown	<i>Eucalyptus sphaerocarpa</i>
Stringybark, blue-leaved	<i>Eucalyptus agglomerata</i>
Stringybark, brown	<i>Eucalyptus baxteri</i>
Stringybark, silvertop	<i>Eucalyptus laevopinea</i>
Stringybark, white	<i>Eucalyptus eugenioides</i>
Stringybark, yellow	<i>Eucalyptus muellerana</i>
Tallowwood	<i>Eucalyptus microcorys</i>
Turpentine	<i>Syncarpia glomulifera</i>
Wollybutt	<i>Eucalyptus longifolia</i>

E2 WINDOWS AND DOORS

Timber species with a density of 650 kg/m³ or greater at a 12 percent moisture content is suitable for window joinery and doorframes where specified in Sections 5 and 6. Examples of suitable timber species are listed in Table E2.

Densities of timber species not listed in Table E2 may be found in AS 1720.2.

Many of the timber species listed in Table E2 from various regions of Australia may not be available in all areas.

TABLE E2
SOME TIMBER SPECIES WITH A DENSITY
OF 650 kg/m³ OR GREATER

Standard trade name	Botanical name
Ash, alpine	<i>Eucalyptus delegatensis</i>
Ash, Crow's	<i>Flindersia australis</i>
Ash, mountain	<i>Eucalyptus regnans</i>
Ash, silvertop	<i>Eucalyptus sieberi</i>
Balau (selangan batu)	<i>Shorea</i> spp.
Bangkirai	<i>Shorea laevifolia</i>
Beech, myrtle	<i>Nothofagus cunninghamii</i>
Belian	<i>Eusideroxylon zwageri</i>
Blackbutt	<i>Eucalyptus pilularis</i>
Blackbutt, New England	<i>Eucalyptus andrewsii</i>
Blackwood	<i>Acacia melanoxylon</i>
Box, brush	<i>Lophosteman confertus</i>
Box, grey	<i>Eucalyptus microcarpa</i>
Box, grey, coast	<i>Eucalyptus bosistoana</i>
Box, white-topped	<i>Eucalyptus quadrangulata</i>
Box, yellow	<i>Eucalyptus melliodora</i>
Brownbarrel	<i>Eucalyptus fastigata</i>
Candlebark	<i>Eucalyptus rubida</i>
Cypress, white	<i>Callitris glaucophylla</i>
Gum, blue, southern	<i>Eucalyptus globulus</i>
Gum, blue, Sydney	<i>Eucalyptus saligna</i>
Gum, grey	<i>Eucalyptus propinqua</i>
Gum, grey, mountain	<i>Eucalyptus cypellocarpa</i>
Gum Maiden's	<i>Eucalyptus maidenii</i>
Gum, manna	<i>Eucalyptus viminalis</i>
Gum, mountain	<i>Eucalyptus dalrympleana</i>
Gum, red, forest	<i>Eucalyptus teteticornis</i>
Gum, red, river	<i>Eucalyptus camaldulensis</i>
Gum, rose	<i>Eucalyptus grandis</i>
Gum, shinning	<i>Eucalyptus nitens</i>
Gum, spotted	<i>Corymbia maculata</i>
	<i>Corymbia henryi</i>
	<i>Corymbia citriodora</i>
Gum, sugar	<i>Eucalyptus cladocalyx</i>
Hardwood, Johnstone River	<i>Backhousia bancroftii</i>
Ironbark, grey	<i>Eucalyptus paniculata</i>
Ironbark, red	<i>Eucalyptus sideroxylon</i>

(continued)

TABLE E2 (continued)

Standard trade name	Botanical name
Jarrah	<i>Eucalyptus marginata</i>
Kapur	<i>Dryobalanops</i> spp.
Karri	<i>Eucalyptus diversicolor</i>
Kempas	<i>Koompassia malaccensis</i>
Keruing	<i>Dipterocarpus</i> spp.
Kwila (Merbau)	<i>Intsia bijuga</i>
Mahogany, Philippine red, dark	<i>Shorea</i> spp.
Mahogany red	<i>Eucalyptus resinifera</i>
Mahogany, southern	<i>Eucalyptus botryoides</i>
Mahogany, white	<i>Eucalyptus acmenoides</i>
Messmate	<i>Eucalyptus obliqua</i>
Messmate, Gympie	<i>Eucalyptus cloeziana</i>
Northern Box (Pelawan)	<i>Tristaniopsis</i> spp.
Oak, American	<i>Quercus</i> spp.
Peppermint, narrow-leaved	<i>Eucalyptus australiana</i>
Pine, celery-top	<i>Phyllocladus asplenifolius</i>
Pine, slash	<i>Pinus elliotii</i>
Ramin	<i>Gonystylus</i> spp.
Rosewood, New Guinea	<i>Pterocarpus indicus</i>
Satinay	<i>Syncarpia hillii</i>
Stringybark, Blackdown	<i>Eucalyptus sphaerocarpa</i>
Stringybark, blue-leaved	<i>Eucalyptus agglomerata</i>
Stringybark, brown	<i>Eucalyptus baxteri</i>
Stringybark, silvertop	<i>Eucalyptus laevopinea</i>
Stringybark, white	<i>Eucalyptus eugenioides</i>
Stringybark, yellow	<i>Eucalyptus muellerana</i>
Tallowwood	<i>Eucalyptus microcorys</i>
Taun	<i>Pometia pinnata</i>
Turpentine	<i>Syncarpia glomulifera</i>
Vitex, New Guinea	<i>Vitex cofassus</i>
Wollybutt	<i>Eucalyptus longifolia</i>

APPENDIX F BUSHFIRE-RESISTING TIMBER

(Normative)

F1 GENERAL

Bushfire-resisting timber is timber that is deemed to be acceptable to withstand exposure up to a BAL—29 condition.

Timber may be 'bushfire-resisting' by means of one or more of—

- (a) the inherent properties of the material itself;
- (b) being impregnated with fire-retardant chemicals; *or*
- (c) the application of fire-retardant coatings or substrates.

F2 TESTING

The following apply:

- (a) To satisfy the requirements for bushfire-resisting timber, timber shall be tested in accordance with AS/NZS 3837 and shall meet the following criteria:
 - (i) The maximum heat release rate shall be not greater than 100 kW/m².
 - (ii) The average heat release rate for 10 min following ignition shall be not greater than 60 kW/m² when the material is exposed to an irradiance level of 25 kW/m².
- (b) Where the timber has been altered by chemicals, the test samples shall be subjected to the regime of accelerated weathering described in Paragraph F3 except that where the timber is protected from the weather, as described in AS 1684.2 and AS 1684.3 (for example, cladding protected by a veranda), accelerated weathering of the test samples is not required before being tested to AS/NZS 3837.

External timbers are deemed to be protected if they are covered by a roof projection (or similar) at 30 degrees or greater to the vertical and they are well detailed and maintained (painted or stained and kept well ventilated).

NOTE: The purpose of testing is to assess timber performance rather than to simulate a bushfire. The irradiance level set for the test is not to be considered to be correlated to the level BAL.

F3 ACCELERATED WEATHERING

Where accelerated weathering is required before testing to AS/NZS 3837, external fire-retardant-coated substrates shall be subjected to the ASTM D2898 Method B weathering regime, with the water flow rate modified to be the same as that within ASTM D2898 Method A.

F4 TESTED SPECIES

The following species have been tested and have met the requirements of Paragraph F2 above:

Standard trade name	Botanical name
Ash, silvertop	<i>Eucalyptus sieberi</i>
Blackbutt	<i>Eucalyptus pilularis</i>
Gum, red, river	<i>Eucalyptus camaldulensis</i>
Gum, spotted	<i>Corymbia maculata</i>
	<i>Corymbia henryi</i>
	<i>Corymbia citriodora</i>
Ironbark, red	<i>Eucalyptus sideroxylon</i>
Kwila (Merbau)	<i>Intsia bijuga</i>
Turpentine	<i>Syncarpia glomulifera</i>

APPENDIX G
EXPLANATION OF BUSHFIRE ATTACK LEVELS (BALs)
(Informative)

G1 GENERAL

To determine the construction requirements for a building site, the threat or risk of bushfire attack needs to be assessed.

G2 1999 and 2009 EDITIONS OF AS 3959

The 1999 edition of AS 3959 provided four levels of risk: Low, Medium, High, Extreme.

This Standard provides six levels of risk: BAL—LOW, BAL—12.5, BAL—19, BAL—29, BAL—40, BAL—FZ.

The BAL system of levels (see Paragraph G4) is based on the potential exposure of the site to heat flux exposure thresholds, expressed as kW/m² (see Table G1). Because the site assessment methodology has changed, it is NOT appropriate to compare the construction requirements from a level in the 1999 edition with those of a level in this Edition.

G3 RADIANT HEAT THRESHOLDS OF PAIN AND IGNITION

In a bushfire, radiant heat levels may be unsafe for humans and could also ignite combustible materials in the vicinity. Table G1 provides an indication of the potential effects of radiant heat levels on both humans and selected materials to assist the reader in understanding the implications of the different BALs.

TABLE G1
TYPICAL RADIANT HEAT INTENSITIES
FOR VARIOUS PHENOMENA

Phenomena	kW/m ²
Pain to humans after 10 s to 20 s	4
Pain to humans after 3 s	10
Ignition of cotton fabric after a long time (piloted) (see Note 2)	13
Ignition of timber after a long time 13 (piloted) (see Note 2)	13
Ignition of cotton fabric after a long time (non-piloted) (see Note 3)	25
Ignition of timber after a long time (non-piloted) (see Note 3)	25
Ignition of gaberdine fabric after a long time (non-piloted) (see Note 3)	27
Ignition of black drill fabric after a long time (non-piloted) (see Note 3)	38
Ignition of cotton fabric after 5 s (non-piloted) (see Note 3)	42
Ignition of timber in 20 s (non-piloted) (see Note 3)	45
Ignition of timber in 10 s (non-piloted) (see Note 3)	55

NOTES:

- 1 Source AS 1530.4—2005.
- 2 Introduction of a small flame to initiate ignition.
- 3 Flame not introduced to initiate ignition.

G4 BUSHFIRE ATTACK LEVELS (BALs) EXPLAINED

The 2009 edition of AS 3959 (this Standard) explains Bushfire Attack Levels (BALs) as follows:

- (a) **BAL—LOW** The risk is considered to be **VERY LOW**.
There is insufficient risk to warrant any specific construction requirements but there is still some risk.
- (b) **BAL—12.5** The risk is considered to be **LOW**.
There is a risk of ember attack.
The construction elements are expected to be exposed to a heat flux not greater than 12.5 kW/m².
- (c) **BAL—19** The risk is considered to be **MODERATE**.
There is a risk of ember attack and burning debris ignited by wind borne embers and a likelihood of exposure to radiant heat.
The construction elements are expected to be exposed to a heat flux not greater than 19 kW/m².
- (d) **BAL—29** The risk is considered to be **HIGH**.
There is an increased risk of ember attack and burning debris ignited by windborne embers and a likelihood of exposure to an increased level of radiant heat.
The construction elements are expected to be exposed to a heat flux not greater than 29 kW/m².
- (e) **BAL—40** The risk is considered to be **VERY HIGH**.
There is a much increased risk of ember attack and burning debris ignited by windborne embers, a likelihood of exposure to a high level of radiant heat and some likelihood of direct exposure to flames from the fire front.
The construction elements are expected to be exposed to a heat flux not greater than 40 kW/m².
- (f) **BAL—FZ** The risk is considered to be **EXTREME**.
There is an extremely high risk of ember attack and burning debris ignited by windborne embers, and a likelihood of exposure to an extreme level of radiant heat and direct exposure to flames from the fire front.
The construction elements are expected to be exposed to a heat flux greater than 40 kW/m².

**Standards Australia**

Standards Australia develops Australian Standards® and other documents of public benefit and national interest. These Standards are developed through an open process of consultation and consensus, in which all interested parties are invited to participate. Through a Memorandum of Understanding with the Commonwealth Government, Standards Australia is recognized as Australia's peak non-government national standards body. Standards Australia also supports excellence in design and innovation through the Australian Design Awards.

For further information visit www.standards.org.au

Australian Standards®

Committees of experts from industry, governments, consumers and other relevant sectors prepare Australian Standards. The requirements or recommendations contained in published Standards are a consensus of the views of representative interests and also take account of comments received from other sources. They reflect the latest scientific and industry experience. Australian Standards are kept under continuous review after publication and are updated regularly to take account of changing technology.

International Involvement

Standards Australia is responsible for ensuring the Australian viewpoint is considered in the formulation of International Standards and that the latest international experience is incorporated in national Standards. This role is vital in assisting local industry to compete in international markets. Standards Australia represents Australia at both the International Organization for Standardization (ISO) and the International Electrotechnical Commission (IEC).

Sales and Distribution

Australian Standards®, Handbooks and other documents developed by Standards Australia are printed and distributed under license by SAI Global Limited.

For information regarding the development of Standards contact:

Standards Australia Limited
GPO Box 476
Sydney NSW 2001
Phone: 02 9237 6000
Fax: 02 9237 6010
Email: mail@standards.org.au
Internet: www.standards.org.au

For information regarding the sale and distribution of Standards contact:

SAI Global Limited
Phone: 13 12 42
Fax: 1300 65 49 49
Email: sales@sai-global.com



STANDARDS
Australia